

(Local) Volcano Infrasound

Jeffrey Johnson (NMT)

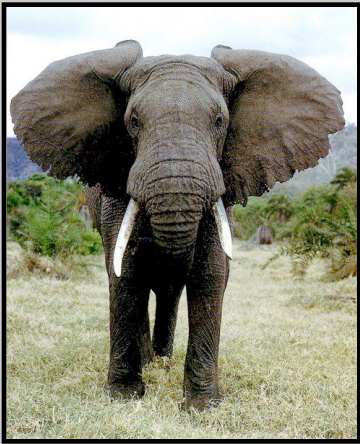
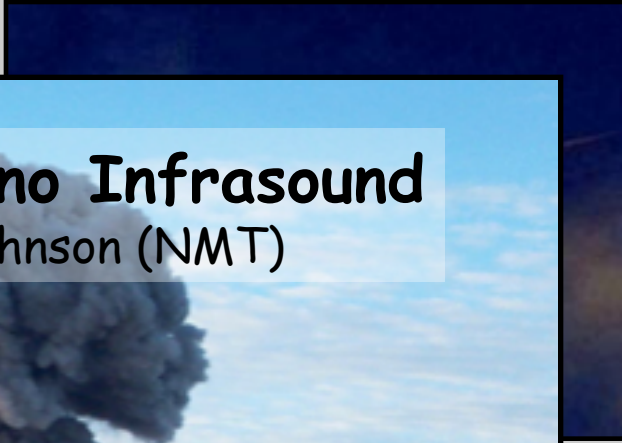

Some interesting facts about infrasound:

Infrasound is sound between ~2mHz (acoustic gravity waves) and 20 Hz (threshold of hearing).

Elephants, whales, hippos, rhinos, giraffes, and alligators use infrasound to communicate! Elephants can "yell" with 15-35 Hz sounds as loud as 117 dB, which can be "heard" tens of kilometers away!

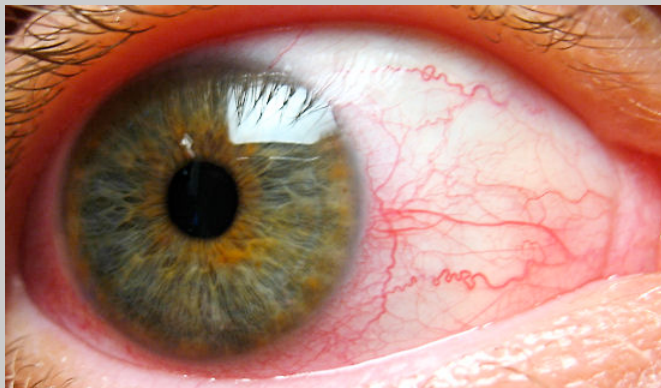

A resonant frequency of the eyeball is at 18 Hz and some ghost sightings have been attributed to excitation of the eye by sounds!

Military has explored infrasound "weapons". Nazi rallies played infrasound to stir up agitation amongst the crowds. Dr. Gavreau during the cold war developed infrasonic "whistles" that were capable of inducing nausea.



Volcanoes produce prodigious infrasound, often peaked at about 1 Hz.

Infrasound: The Good News

Infrasound is typically measured in Pa and can be adequately recorded with low-cost low-frequency sensitive microphones.

Sound waves in atmosphere come in only one elastic flavor (compressional waves)

Intrinsic attenuation of infrasound is very low

Structure of the atmosphere is relatively homogeneous giving rise to (relatively) predictable propagation paths at local distances

And now the bad news:

Structure of atmosphere changes, dependend upon winds and temperatures.

Solution: Put microphones local to the source

Infrasound recordings are often contaminated by noise caused by winds (atmospheric turbulence) and microbaroms (i.e., low frequency ocean wave sounds)

Solution: Filter out microbaroms and deploy sensors in low noise environments

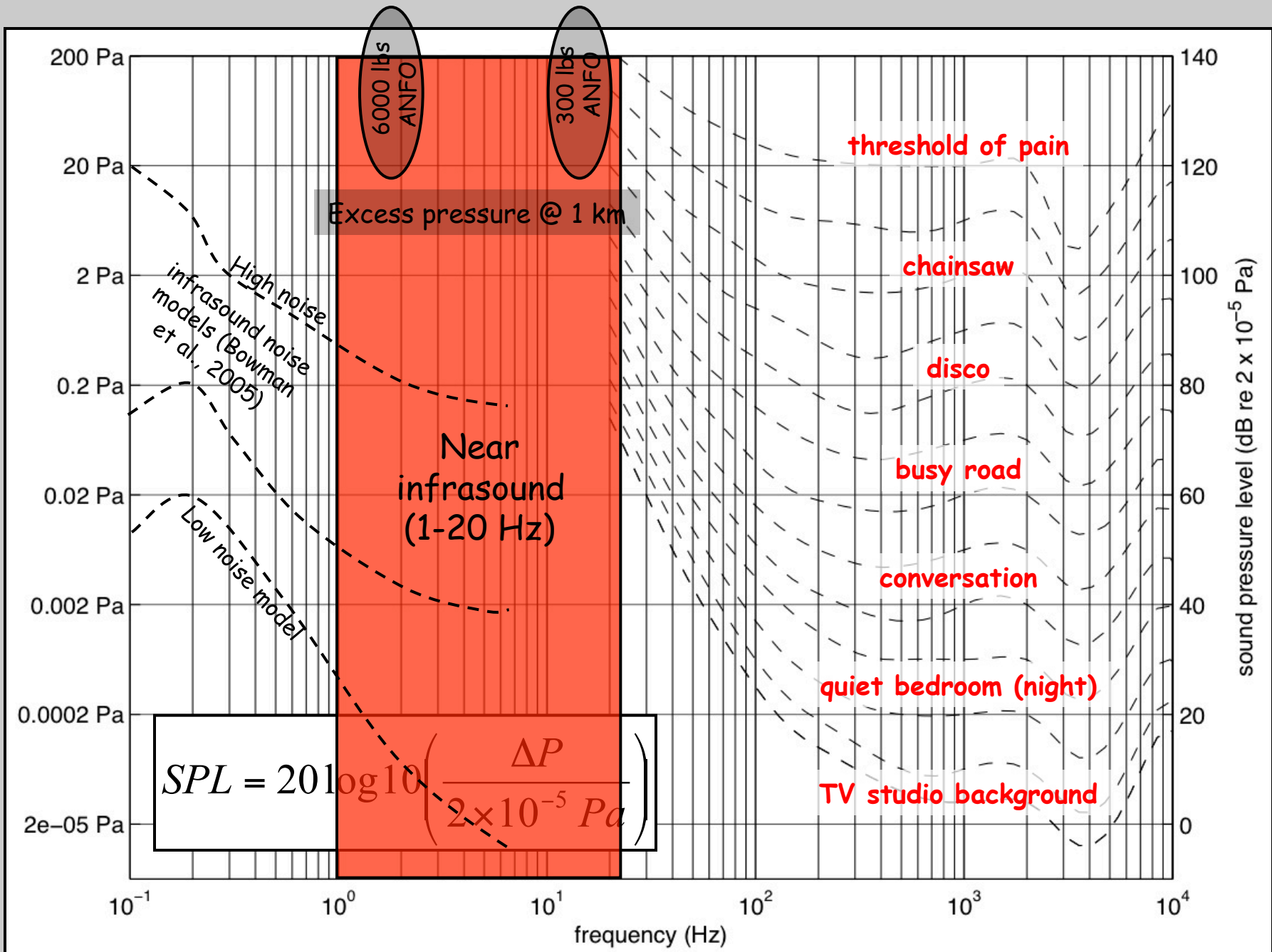

Some local observations of volcano infrasound in the literature

- Bouche, E. et al., 2010. The role of large bubbles detected from acoustic measurements on the dynamics of **Erta 'Ale** lava lake (Ethiopia). *Earth and Planetary Science Letters*, 295: 37-48.
- Braun, T. and Ripepe, M., 1993. Interaction of seismic and air waves as recorded at **Stromboli** Volcano. *Geophys. Res. Lett.*, 20: 65-68.
- Cannata, A., Montalto, P., Privitera, E., Russo, G. and Gresta, S., 2009. Tracking eruptive phenomena by infrasound: May 13, 2008 eruption at **Mt. Etna**. *Geophys. Res. Lett.*, 36(L05304).
- Fee, D. et al., 2010. Infrasonic harmonic tremor and degassing bursts from Halemaumau Crater, **Kilauea** Volcano, Hawaii. *J. Geophys. Res.*
- Firstov, P.P. and Storcheus, A.V., 1987. Acoustic signals that accompanied the March-June 1983 eruption at **Klyuchevskoy** Volcano. *Volcanol. Seismol.*, 5: 66-80.
- Garces, M.A. et al., 1999. Infrasonic precursors to a Vulcanian eruption at **Sakurajima** Volcano, Japan. *Geophys. Res. Lett.*, 26(16): 2537-2540.
- Hagerty, M.T., Schwartz, S.Y., Garces, M.A. and Protti, M., 2000. Analysis of seismic and acoustic observations at **Arenal** Volcano, Costa Rica, 1995-1997. *Journal of Volcanology and Geothermal Research*, 101(1-2): 27-65.
- Johnson, J.B., 2007. On the relation between infrasound, seismicity, and small pyroclastic explosions at **Karymsky** Volcano. *Journal of Geophysical Research-Solid Earth*, 112(B8).
- Johnson, J.B. and Lees, J.M., 2010. Long period infrasound at **Santiaguito** produced by rapid dome inflation. *Geophys. Res. Lett.*
- Jones, K., Johnson, J.B., Aster, R., Kyle, P. and McIntosh, W., 2008. Infrasonic tracking of large bubble bursts and ash venting at **Erebus** volcano, Antarctica. *J. Volc. Geotherm. Res.*, 177: 661-672.
- Kobayashi, T., Ida, Y. and Ohminato, T., 2005. Small inflation sources producing seismic and infrasonic pulses during the 2000 eruptions of **Miyake-jima**, Japan. *Earth and Planetary Science Letters*, 240(2): 291-301.
- Lees, J.M., Johnson, J.B., Ruiz, M., Troncoso, L. and Welsh, M., 2008. **Reventador** Volcano 2005: Eruptive activity inferred from seismo-acoustic observation. *Journal of Volcanology and Geothermal Research*, 176(1): 179-190.
- Lees, J.M. and Ruiz, M., 2008. Non-linear explosion tremor at **Sangay**, Volcano, Ecuador. *Journal of Volcanology and Geothermal Research*, 176(1): 170-178.
- Lyons, J.J., Waite, G.P., Rose, W.I. and Chigna, G., 2010. Patterns in open vent, strombolian behavior at **Fuego** volcano, Guatemala, 2005-2007. *Bulletin of Volcanology*, 72(1): 1-15.
- Petersen, T., De Angelis, S., Tytgat, G. and McNutt, S.R., 2006. Local infrasound observations of large ash explosions at **Augustine** Volcano, Alaska, during January 11-28, 2006. *Geophysical Research Letters*, 33(12).
- Ripepe, M., De Angelis, S., Lacanna, G. and Voight, B., 2010. Observation of infrasonic and gravity waves at Soufriere Hills Volcano, **Montserrat**. *Geophys. Res. Lett.*, 37(L00E14).
- Ripepe, M. et al., 2010. Monochromatic infrasonic tremor driven by persistent degassing and convection at **Villarrica** Volcano, Chile. *Geophys. Res. Lett.*, 37(L15303).
- Ruiz, M., Lees, J.M. and Johnson, J.B., 2006. Source constraints of **Tungurahua** volcano explosion events. *Bulletin of Volcanology*, 68(5): 480-490.
- Vergnolle, S. and Caplan-Auerbach, J., 2006. Basaltic thermals and subplinian plumes: Constraints from acoustic measurements at **Shishaldin** volcano, Alaska. *Bulletin of Volcanology*, 68(7-8): 611-630.
- Yamasato, H., 1998. Nature of infrasonic pulse accompanying low frequency earthquake at **Unzen** Volcano, Japan. *Bull. Volcanol. Soc. Japan*, 43: 1-13.
- Yokoo, A. and Iguchi, M., 2010. Using infrasound waves from eruption video to explain ground deformation preceding the eruption of **Suwanosejima** volcano, Japan. *J. Volc. Geotherm. Res.*, 196(3-4): 287-294.

Some regional and global observations of volcano infrasound

- Antier, K., Le Pichon, A., Vergnolle, S., Zielinski, C. and Lardy, M., 2007. Multiyear validation of the NRL-G2S wind fields using infrasound from **Yasur**. *Journal of Geophysical Research-Atmospheres*, 112(D23).
- Banister, J.R., 1984. Pressure wave generated by the **Mount St. Helens eruption**. *J Geophys. Res.*, 89(D3): 4895-4904.
- Evers, L.G. and Haak, H.W., 2005. The detectability of infrasound in the Netherlands from the Italian volcano Mt. **Etna**. *Journal of Atmospheric and Solar-Terrestrial Physics*, 67(3): 259-268.
- Fee, D., Garces, M. and Steffke, A., 2010. Infrasound from **Tungurahua** Volcano 2006-2008: strombolian to plinian eruptive activity. *J. Volc. Geotherm. Res.*, 193: 67-81.
- Fee, D., Steffke, A. and Garces, M., 2010. Characterization of the 2008 **Kasatochi** and Okmok eruptions using remote infrasound arrays. *J Geophys. Res.*, 115(D00L10).
- Gorshkov, G.S., 1959. Gigantic eruption of the Volcano **Bezymianny**. *Bull. Volcan.*, 20: 77-109.
- Liszka, L. and Garces, M.A., 2002. Infrasonic observations of the **Hekla** eruption of February 26, 2000. *J. Low Frequency Noise Vibration and Active Control*, 21(1): 1-8.
- Matoza, R. et al., 2010. Infrasonic observations of the June 2009 **Sarychev** Peak eruption, Kuril Islands: implications for infrasonic monitoring of explosive volcanism. *J. Volc. Geotherm. Res.*
- Tahira, M., Nomura, M., Sawada, Y. and Kamo, K., 1996. Infrasonic and acoustic-gravity waves generated by the Mount **Pinatubo** eruption of June 15, 1991. In: C.G. Newhall and R.S. PUNONGBAYAN (Editors), *Fire and Mud*. University of Washington Press, Seattle, pp. 601-614.
- Wilson, C.R. and Olson, J.V., 2005. I53US and I55US signals from **Manam** Volcano. *Inframatics*, 9: 31-35.
- Wilson, C.R., Olson, J.V., Osborne, D.L. and Le Pichon, A., 2003. Infrasound from **Erebus** Volcano at I55US in Antarctica. *Inframatics*, 4: 1-8.
- Wilson, C.R. et al., 2006 Infrasonic array observations at I53US of the 2006 **Augustine** Volcano eruptions. *Inframatics*, 13: 11-25.

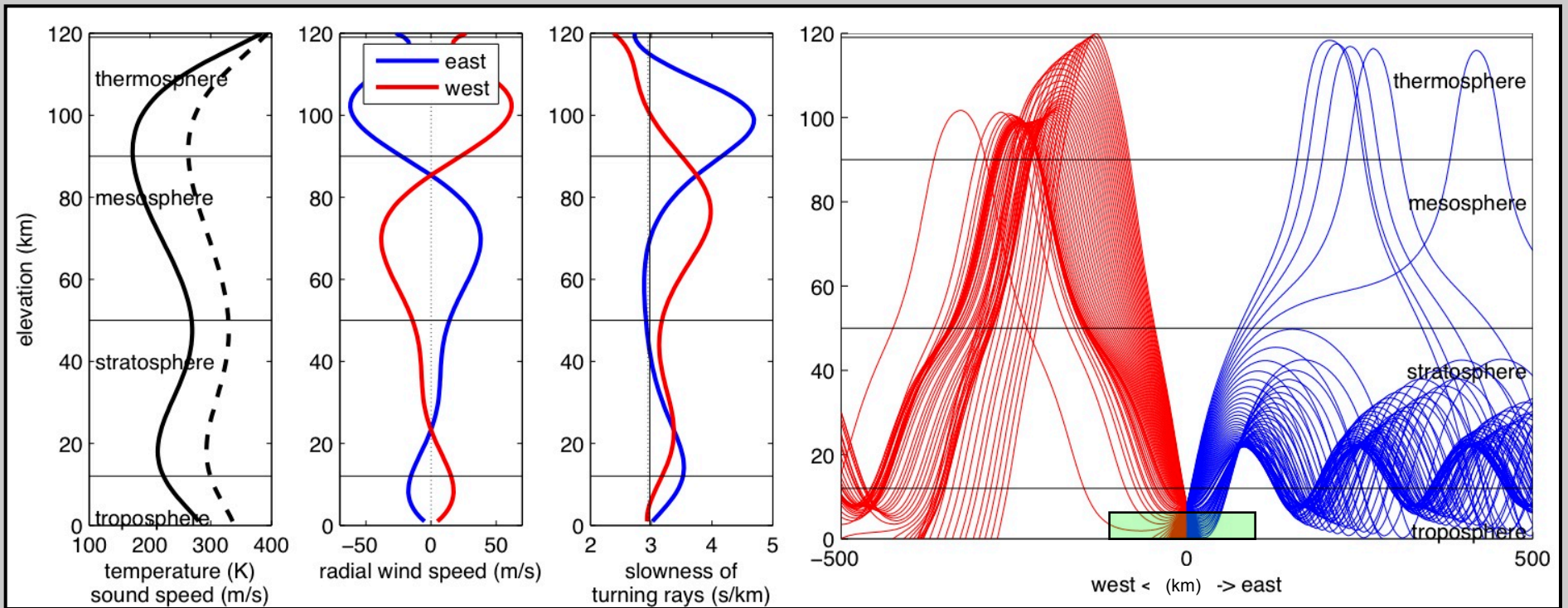

- **Local infrasound:** on flanks of (strato)volcano: $< \sim 10$ km (excess pressure decay as $1/r$)
- **Regional infrasound:** out to first stratospheric / thermospheric refraction: $< \sim 500$ km
- **Global infrasound:** worldwide (pressure decay as $1/r^{1/2}$)

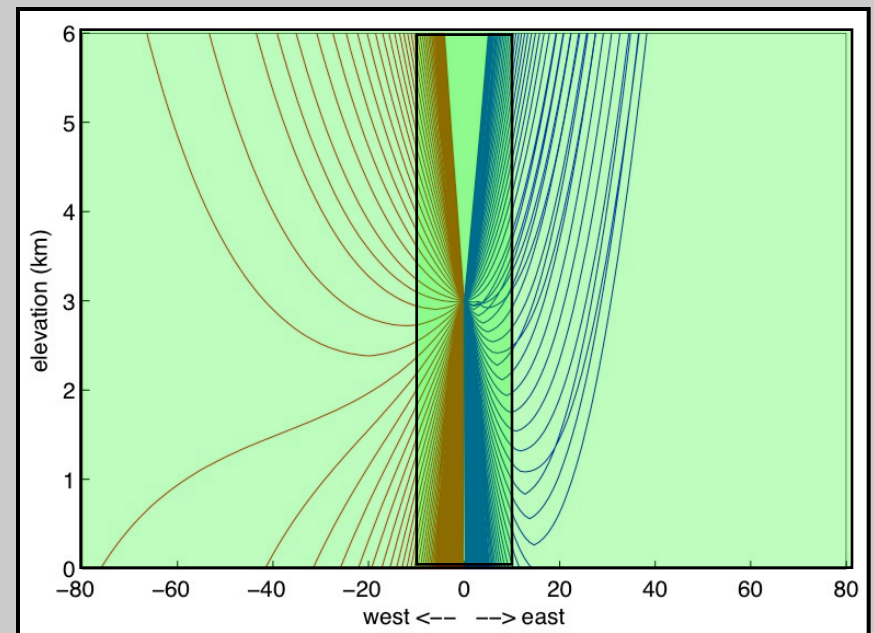

Infrasonic observations of the June 2009 Sarychev Peak eruption, Kuril Islands: implications for monitoring of explosive volcanism

Matoza, R.S., Pichon, Vergoz, Herry, Lalande, Lee, Che, and Rybin, *Journal of Volcanological and Geothermal Research* (2010)

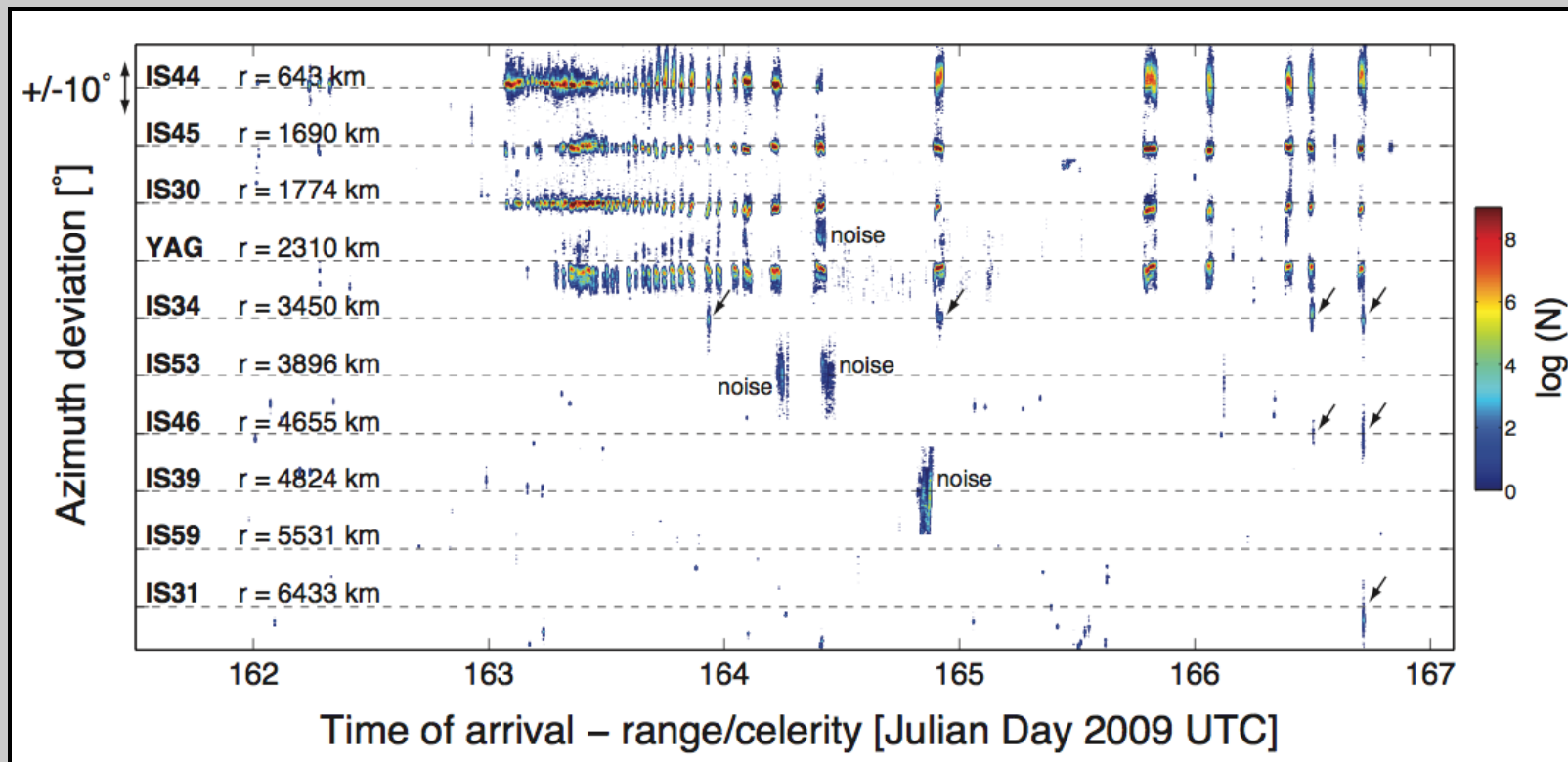
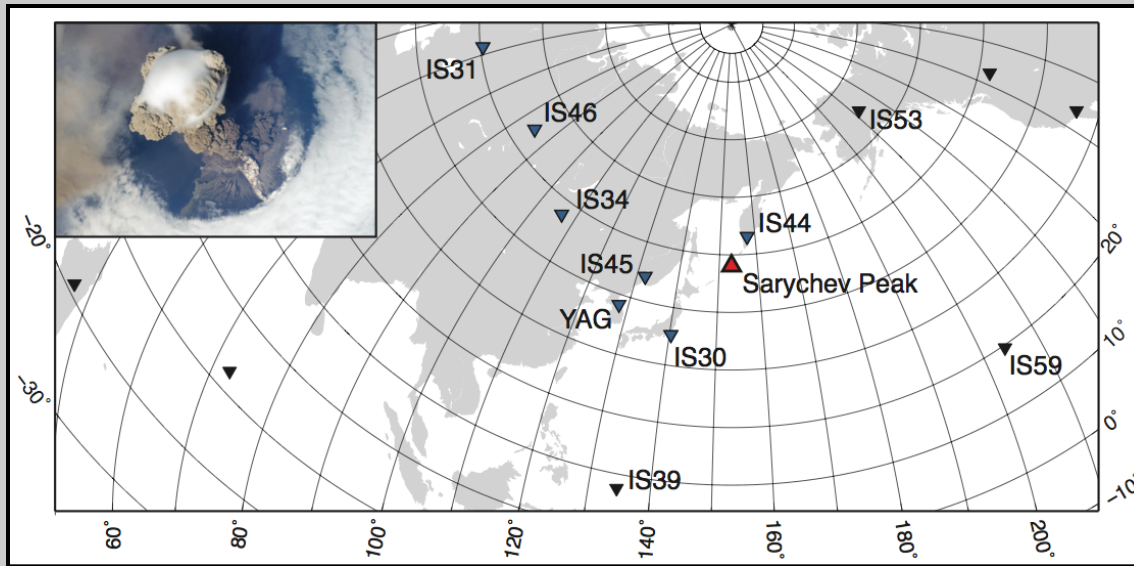

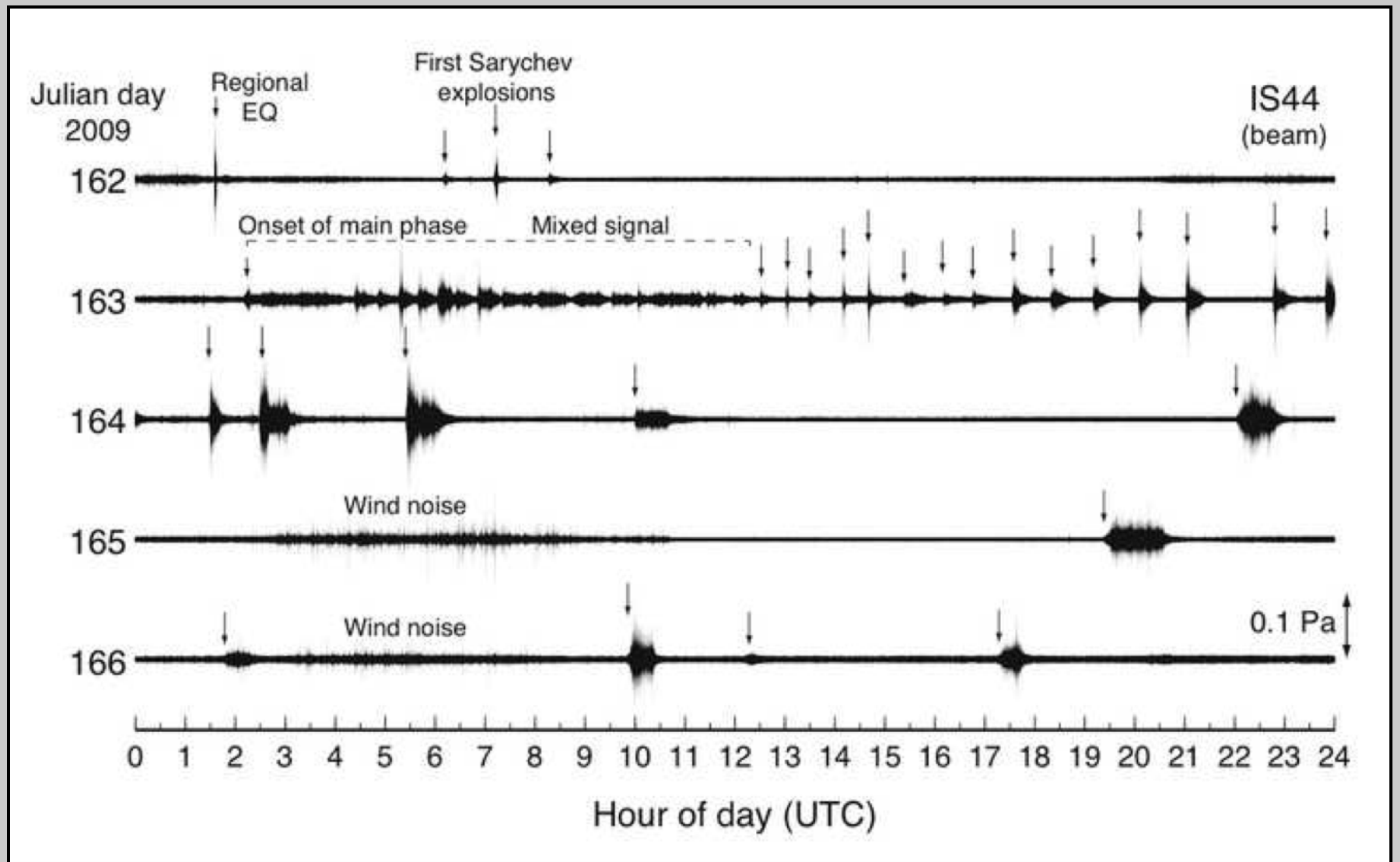

Quantifying infrasound magnitudes:

By amplitude: Excess pressure (p) amplitudes are most frequently measured in passcals (Pa) and should be scaled back to a common distance, e.g. 1 km, to indicate the equivalent excess pressure that *would* be recorded at 1 km ($r_{red} = 1000\text{ m}$). At local distances (r), where sound propagation is approximated as radial and pressure decays as $1/r$, *reduced pressure* can be calculated as:

$$p_{red} = p \times \frac{r}{r_{red}}$$

At regional or global distances geometric spreading (in the absence of attenuation) causes a less rapid reduction in amplitude that is more like $r^{1/2}$.

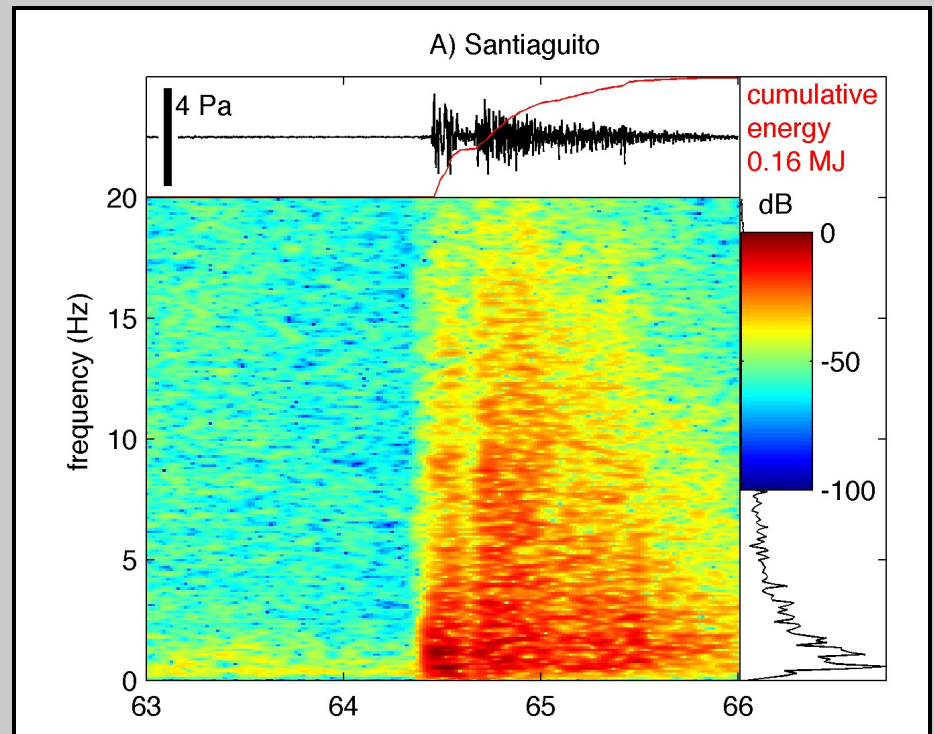
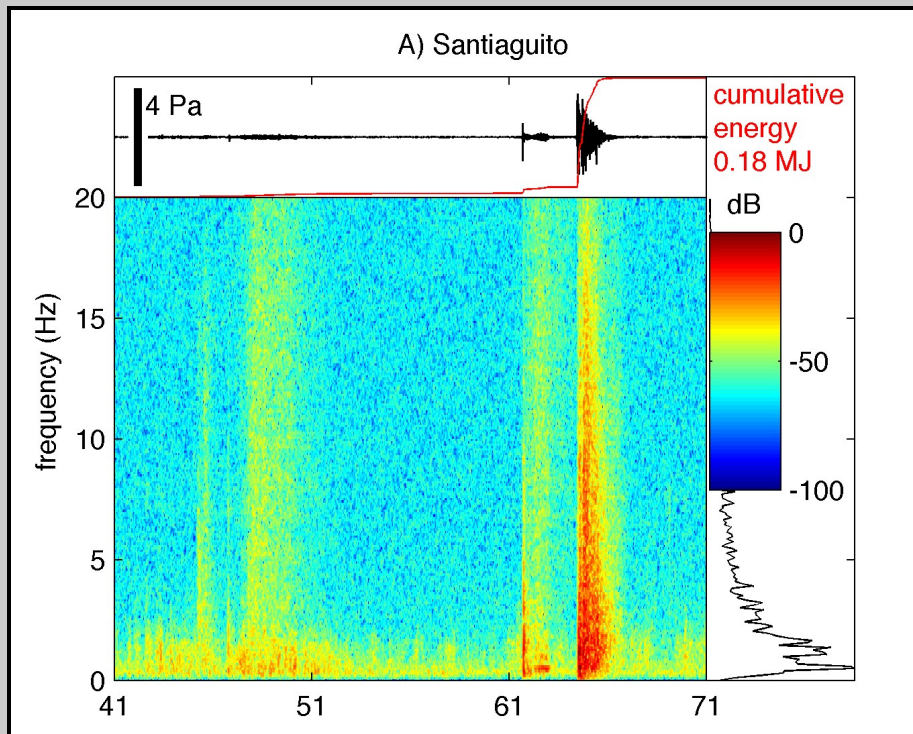

Santiaguito (Guatemala) - pyroclastic-laden eruptions with buoyant plumes up to ~1.2 km. Only about 100 Watts of acoustic power is associated with time averaged Santiaguito eruptive behavior and is dominated by explosive events. Up to 3000 Watts is generated during eruption.

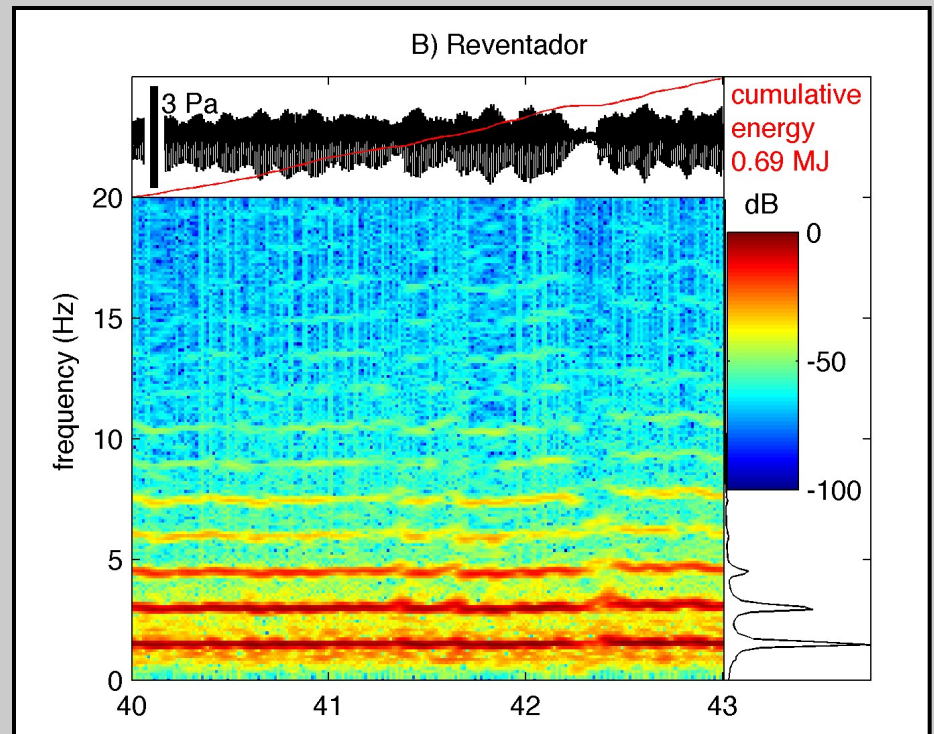
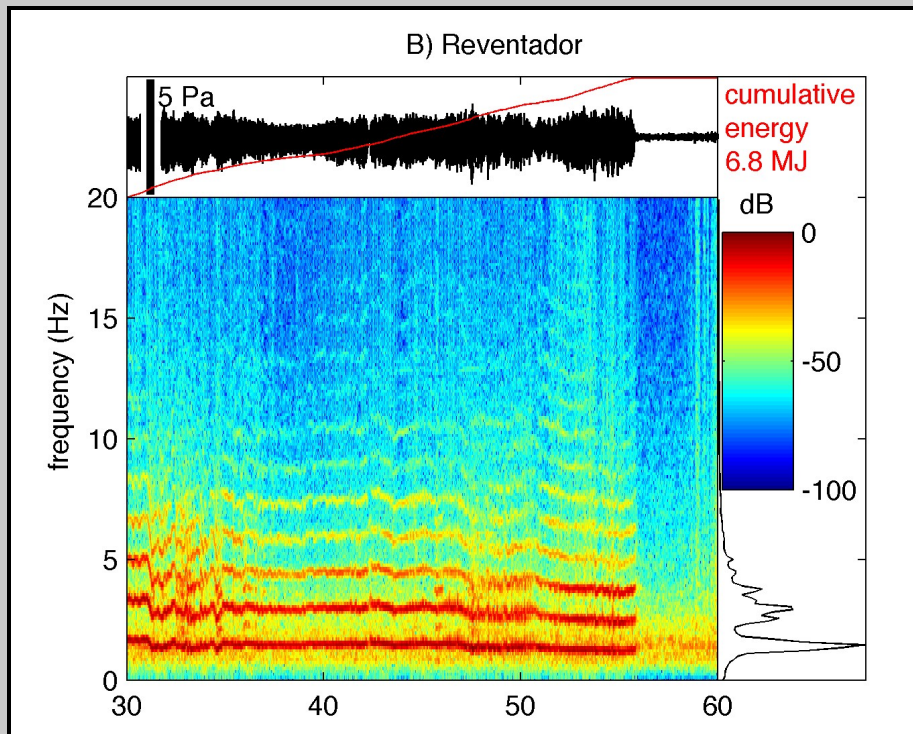

Reventador (Ecuador) - continuous degassing giving rise to ~500-m-high vapor plume. Infrasound is dominated by harmonic tremor ('chugging'), which produces consistent levels of sound and sound power (~4000 Watts) until shutting off.

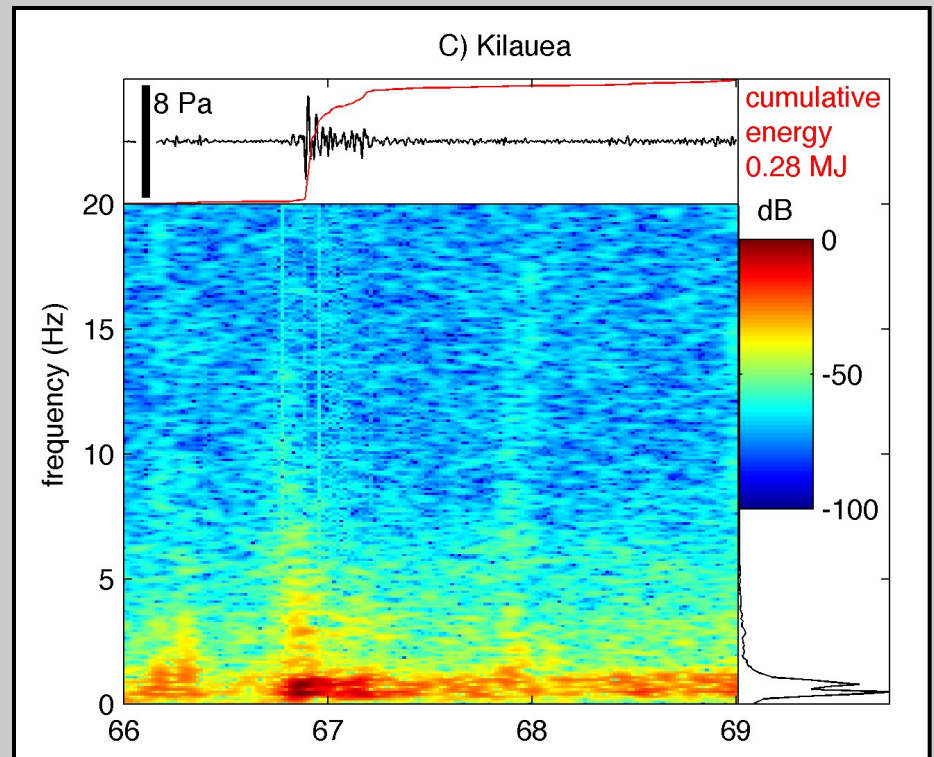
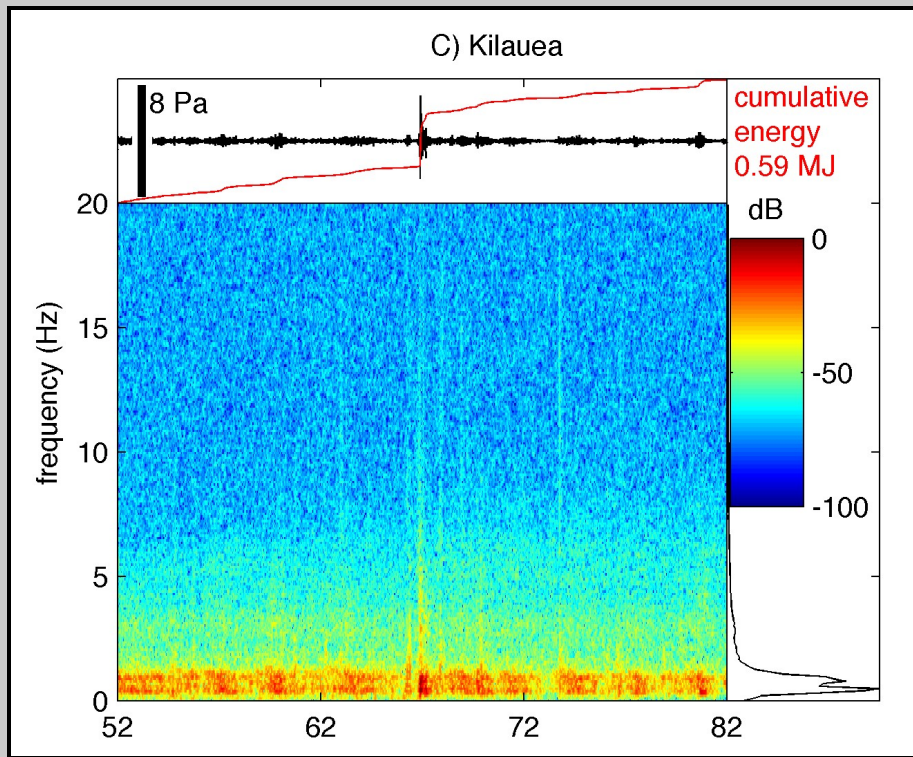

Halemaumau, Kilauea (Hawaii) - striking and long-lived monotonic tremor is continuous for months and associated with open-vent lava lake degassing. Transient infrasound pulses are thought to represent explosions instigated by pit crater collapse during which ash and blocks are expelled several hundred meters. Long term averaged acoustic power is ~ 300 W.

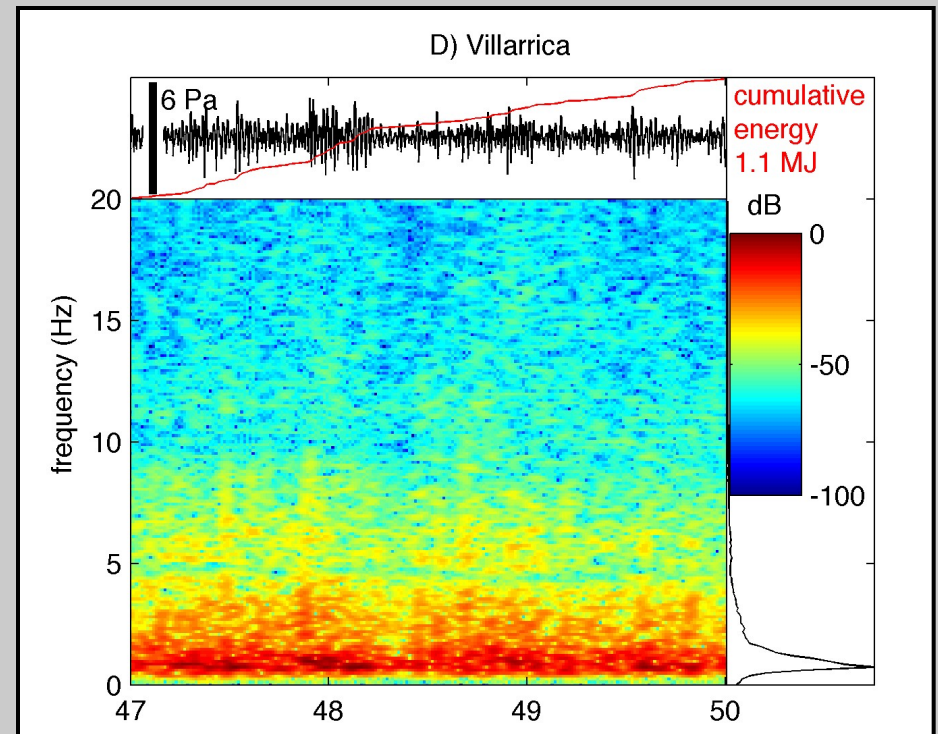
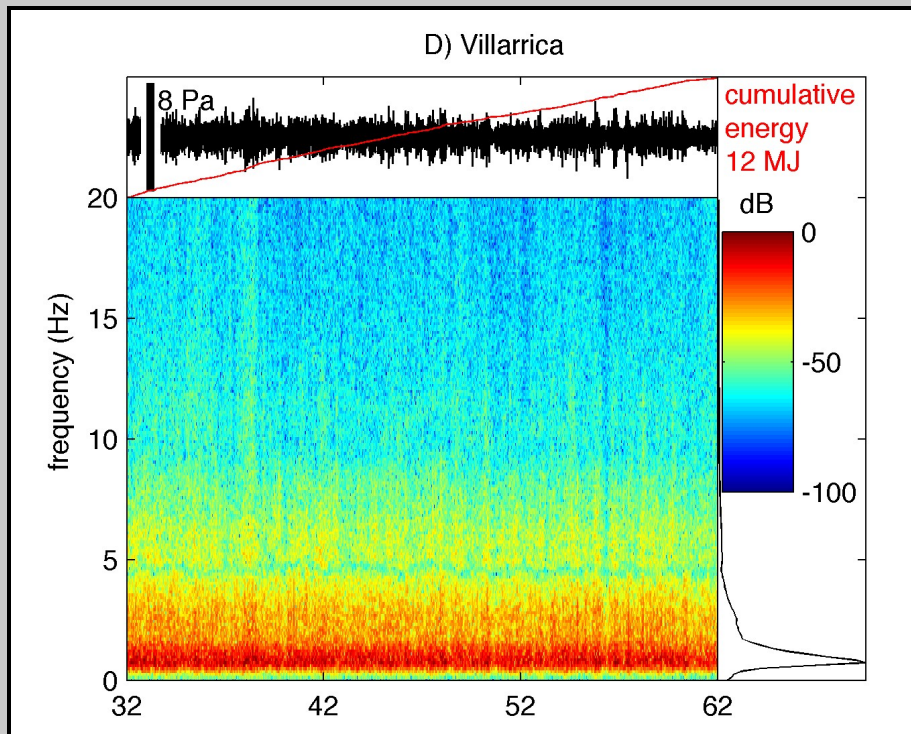

Villarrica (Chile) - like Kilauea, another monotonic tremor system associated with open-vent lava lake activity. Energy is sharply peaked at 0.77 Hz. Small Strombolian explosions at bottom of crater are not associated with infrasound transients. Sustained acoustic power is ~6500 W.

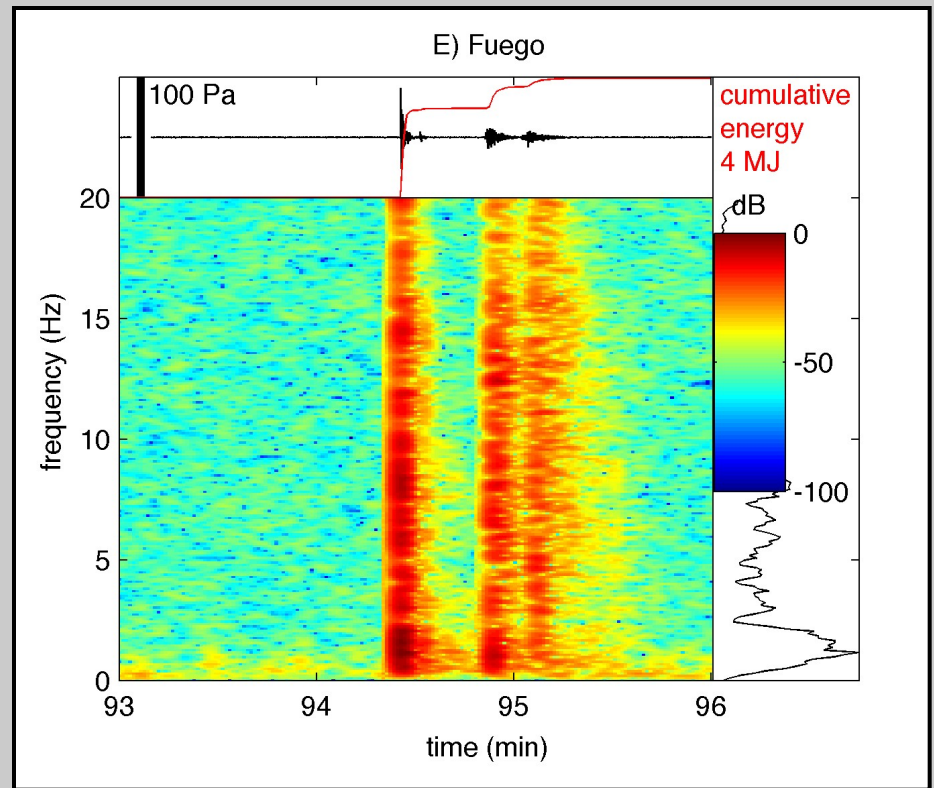
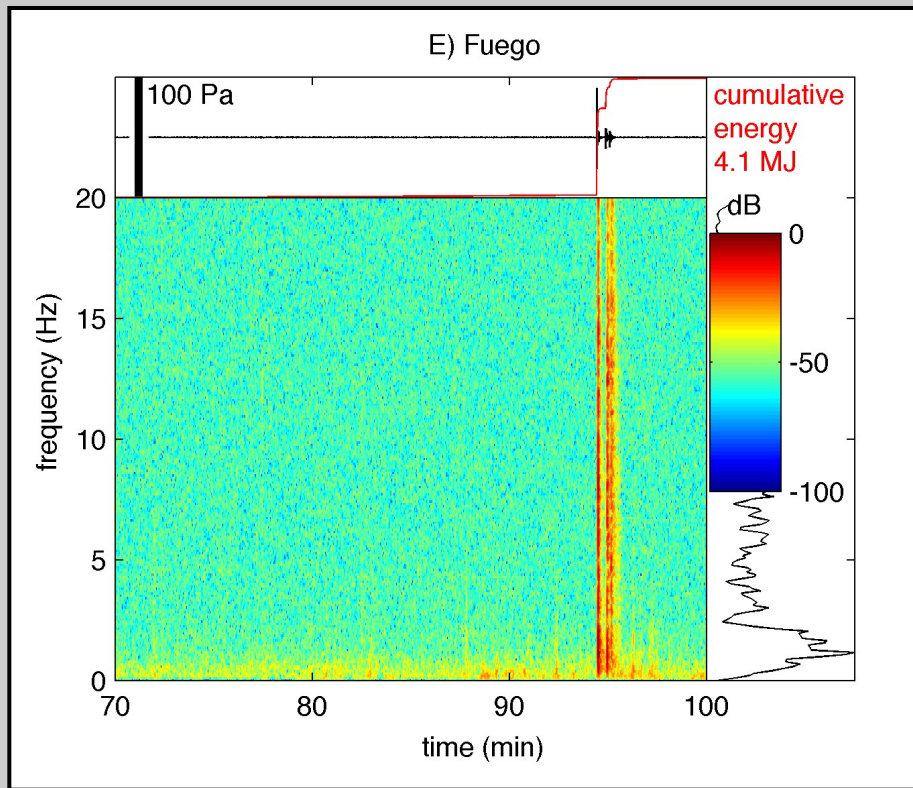

Fuego (Guatemala) - short-duration Strombolian/Vulcanian explosions generate intense, short-lived infrasound transients, which are relatively broad band in character. Almost all acoustic energy is released during these short events when acoustic power reaches $\sim 100,000$ W. Long-term averaged acoustic power is ~ 2200 W.

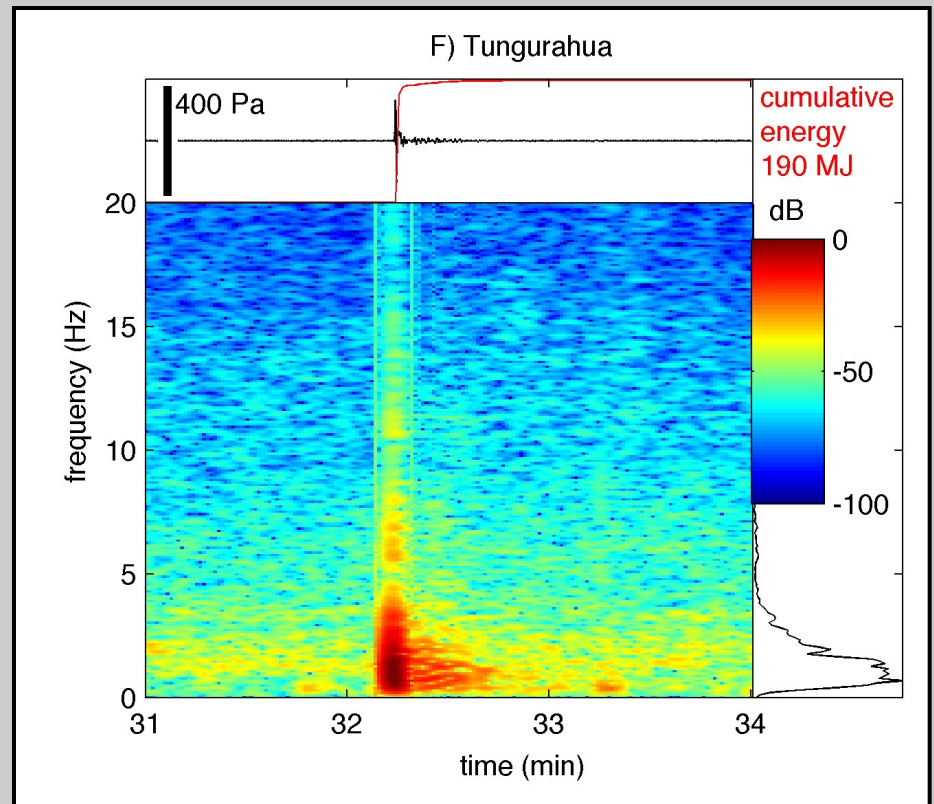
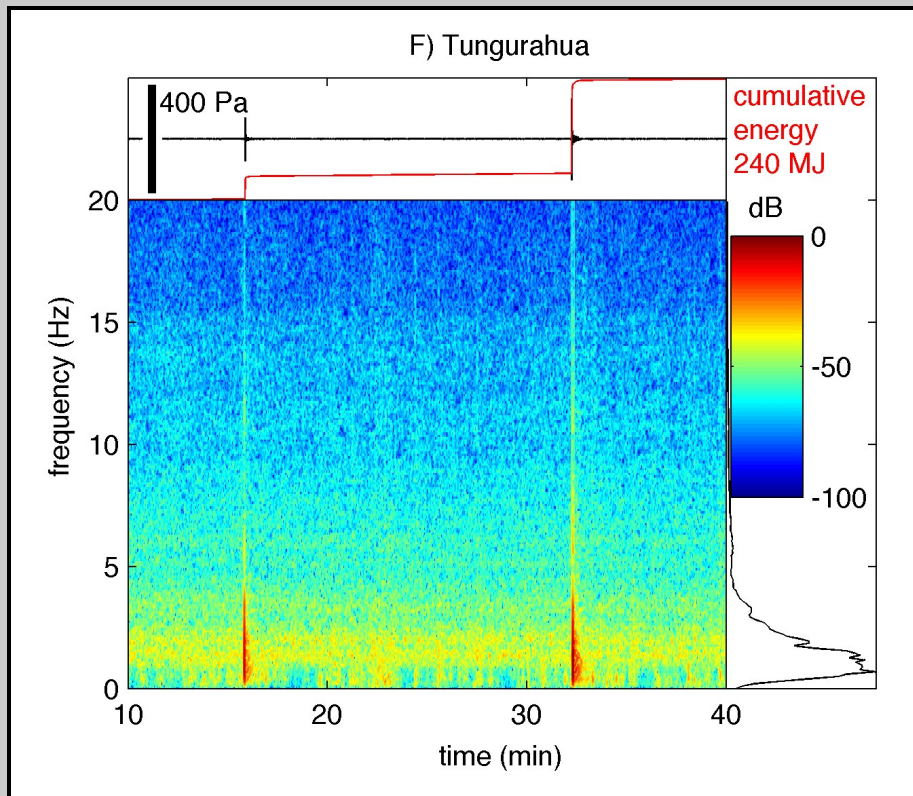

Tungurahua (Ecuador) - short-duration Vulcanian explosions ejecting ballistics to ~2 km generate intense, short-lived infrasound transients, which are confined to frequencies below about 5 Hz. Peak acoustic power is as great as 10 MWatts (10,000,000 Watts) and time-averaged power is more than 100,000 W.

	Trace reference start time (yyyy:ddd:hh)	Station distance (km)	max pressure (Pa)	Reduced pressure at 1 km (Pa)	30-minute total energy (MJ) from Figure 1
a) Santiaguito	2009:001:11	0.4	4.4	1.8	0.18
b) Reventador	2005:236:16	1.7	0.9	1.5	6.8
c) Kilauea	2008:190:09	2.4	1.3	3.2	0.59
d) Villarrica	2010:22:12	0.1	58	2.9	12
e) Fuego	2007:117:13	7.0	5.9	41	4.1
f) Tungurahua	2009:165:15	5.5	27	150	240

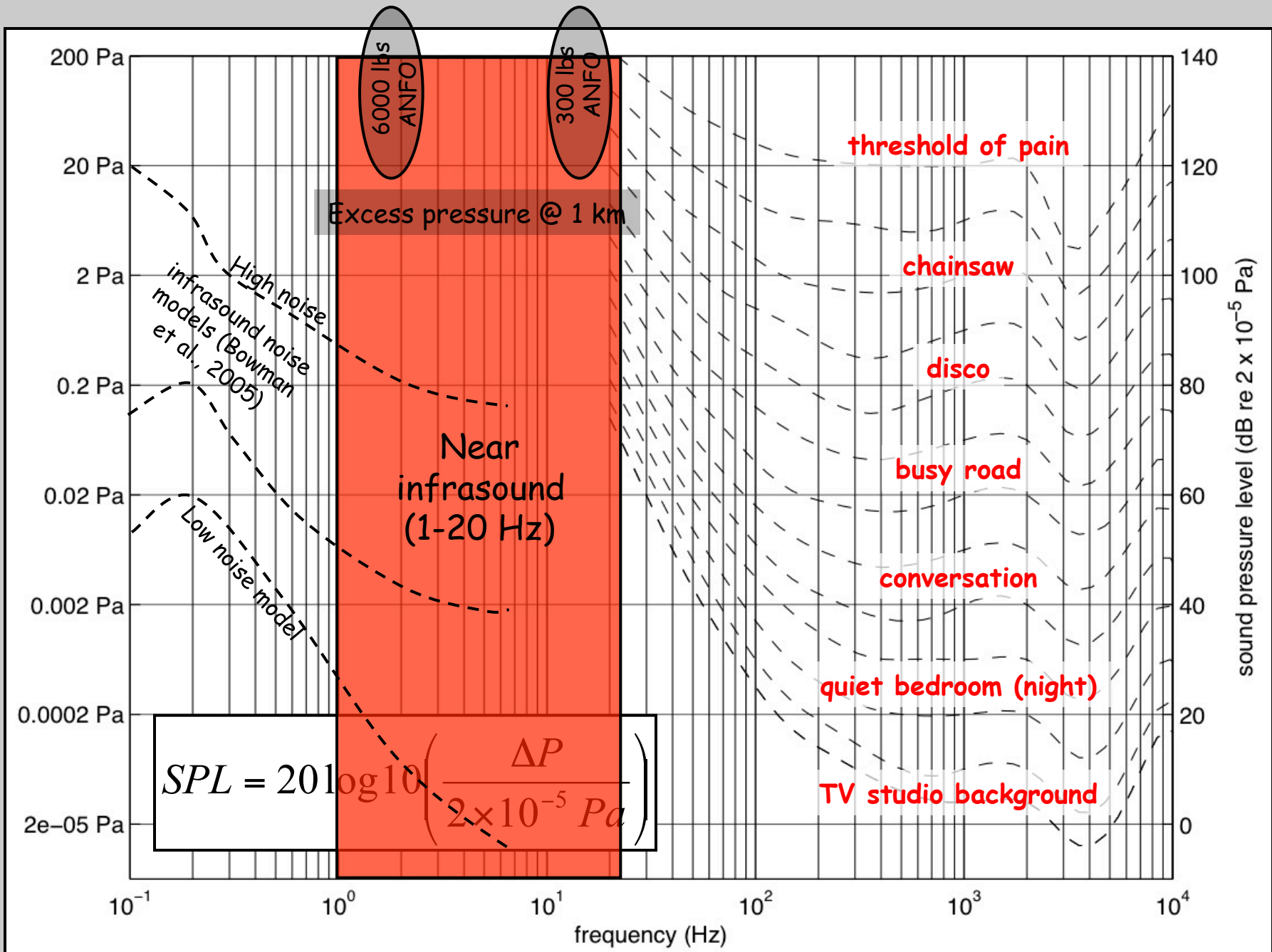

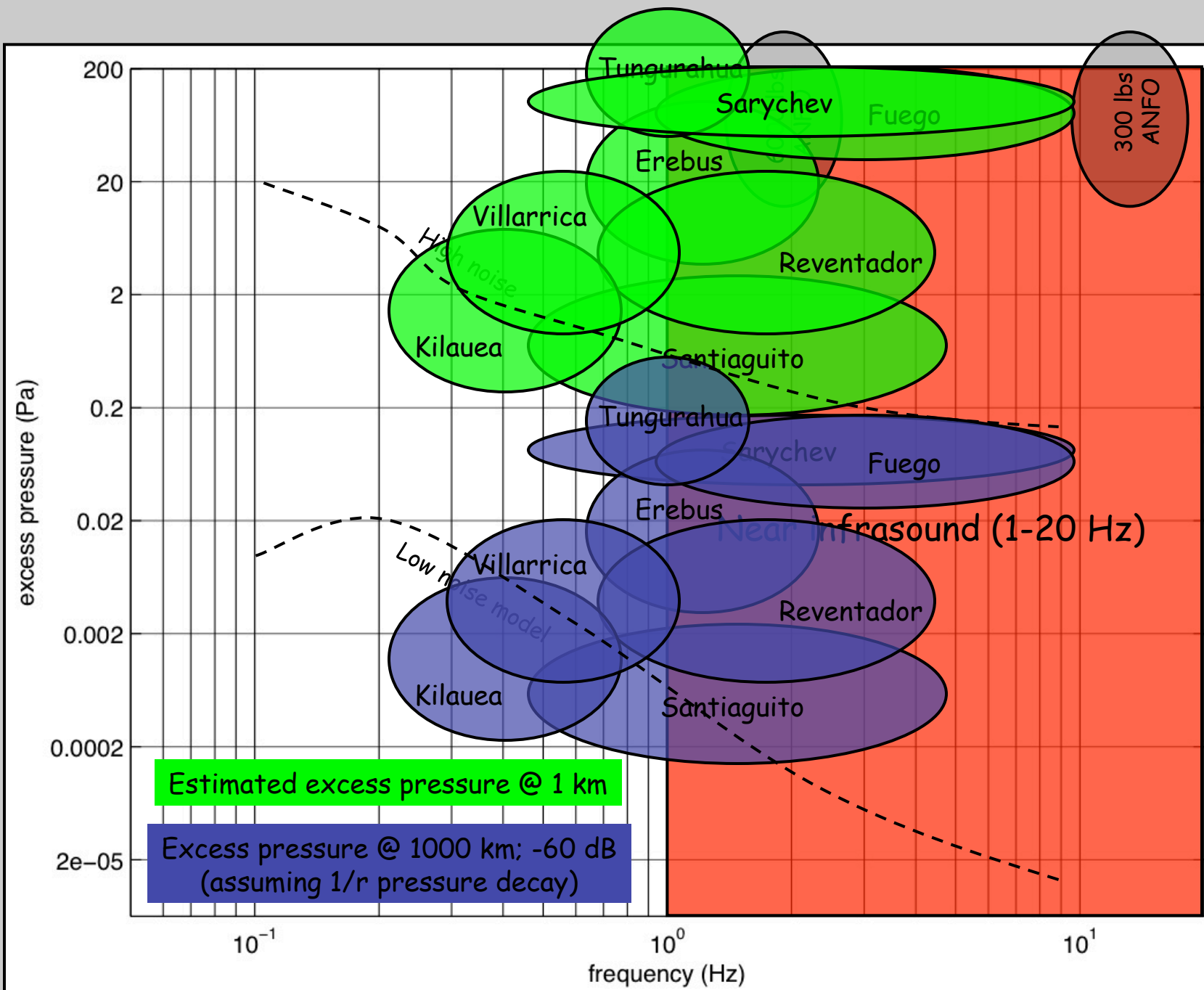



#2 01/01/06 16:40:03

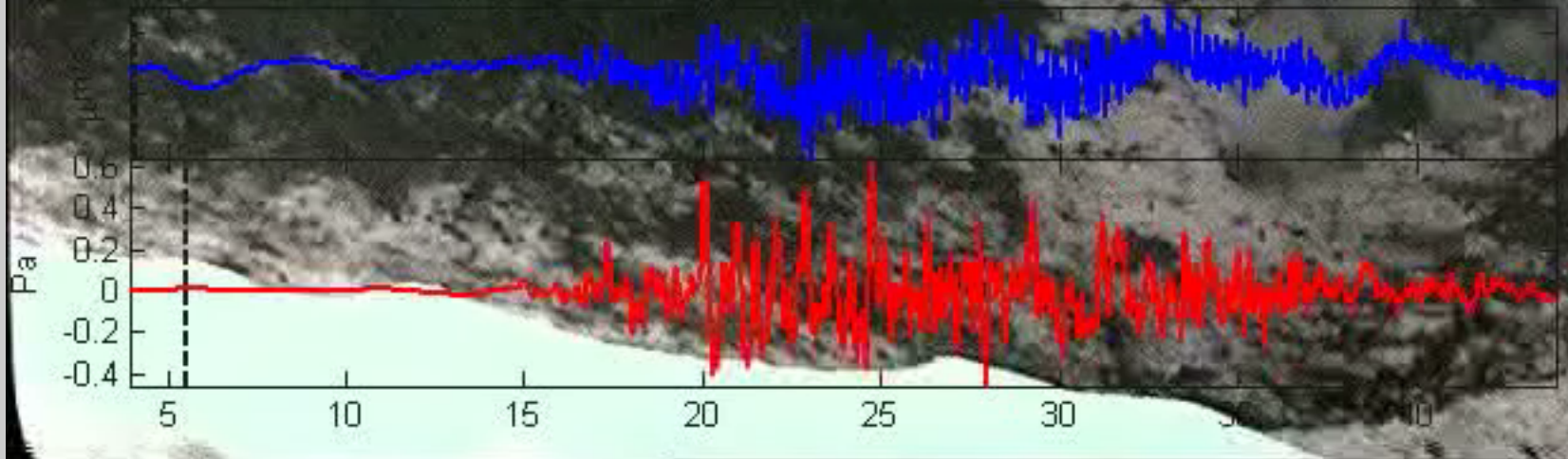

#2 12/31/05 04:32:20

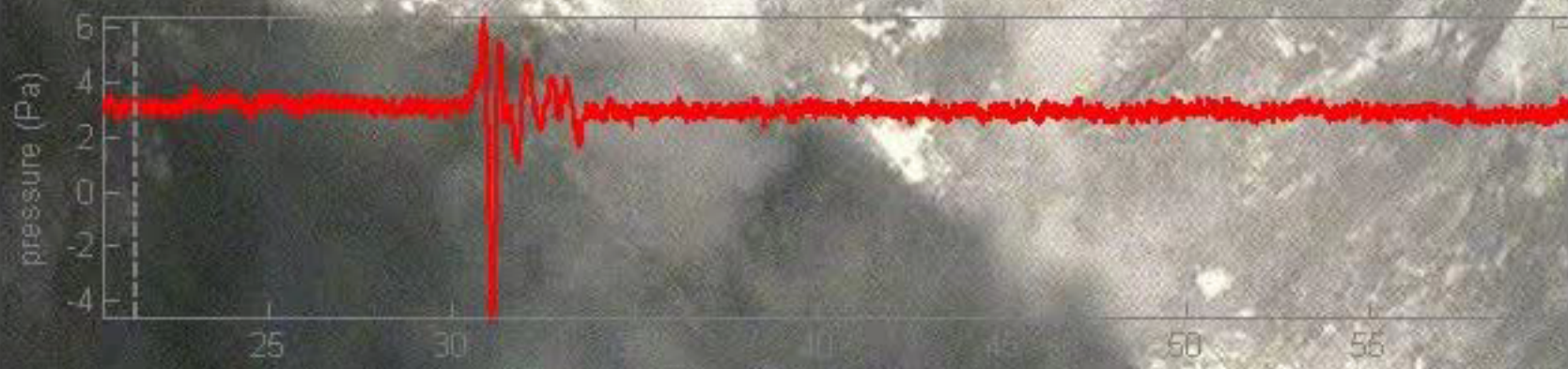

#2 12/31/05 10:53:37



#2 12/31/05 11:44:29

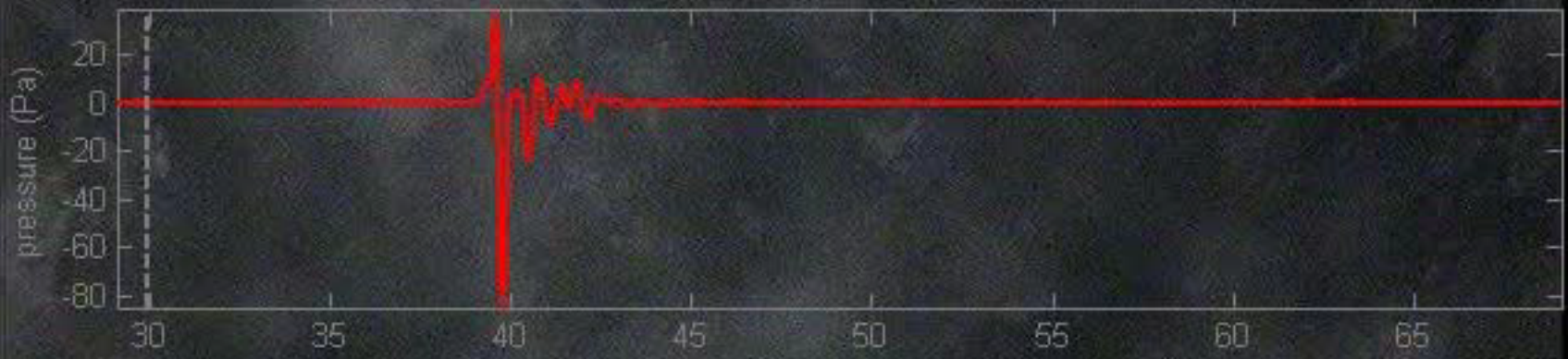

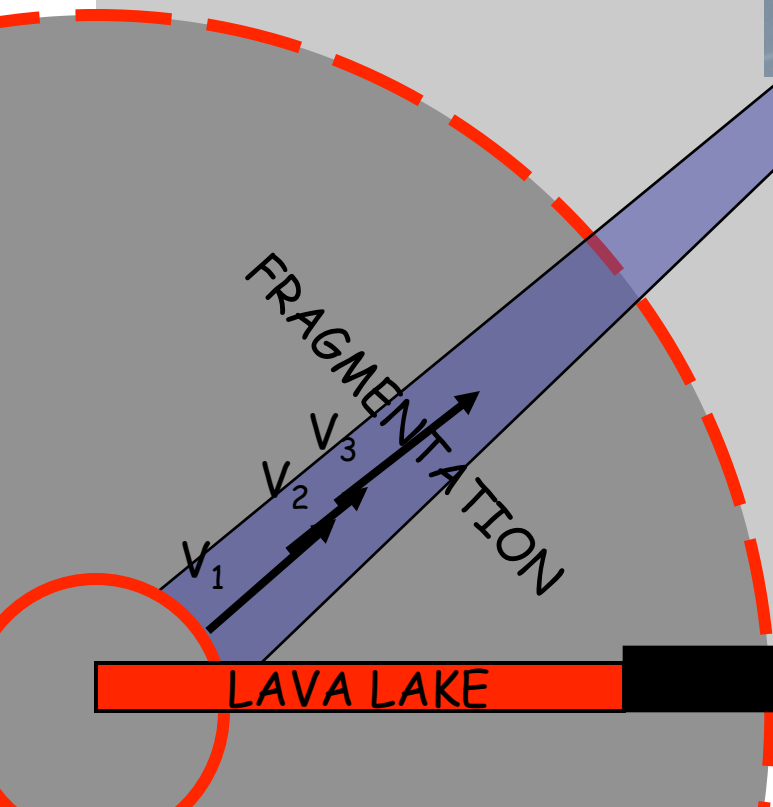

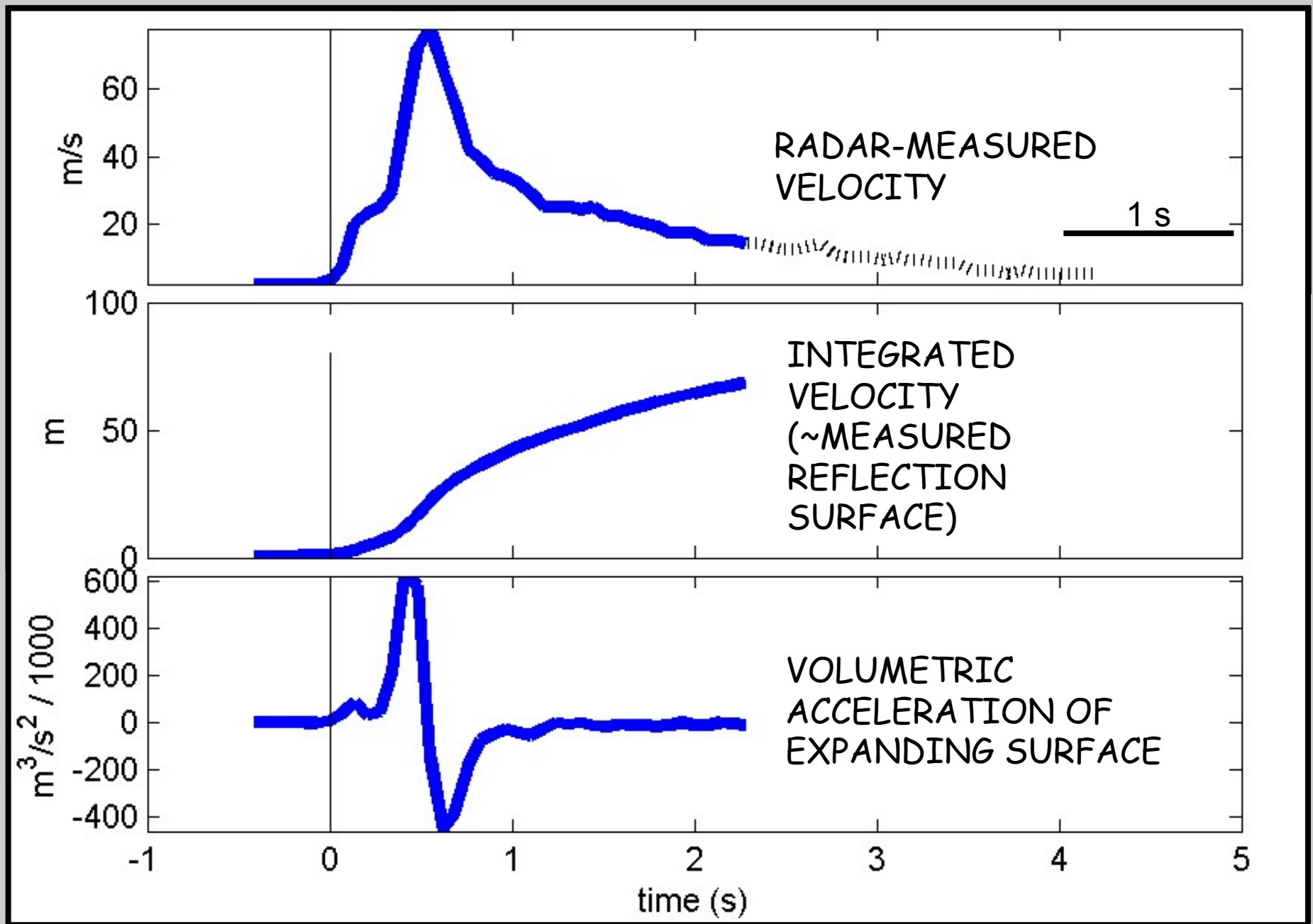

Lighthill's Acoustic Monopole Source (assuming compact source and linear wave propagation)

$$p(r, t) = \frac{Q(t - r/c)}{2\pi r}$$

Where $p(r, t)$ is the excess pressure (in Pa) and Q is the source strength, or density x "volumetric acceleration" (in kg/s^2) of the atmosphere

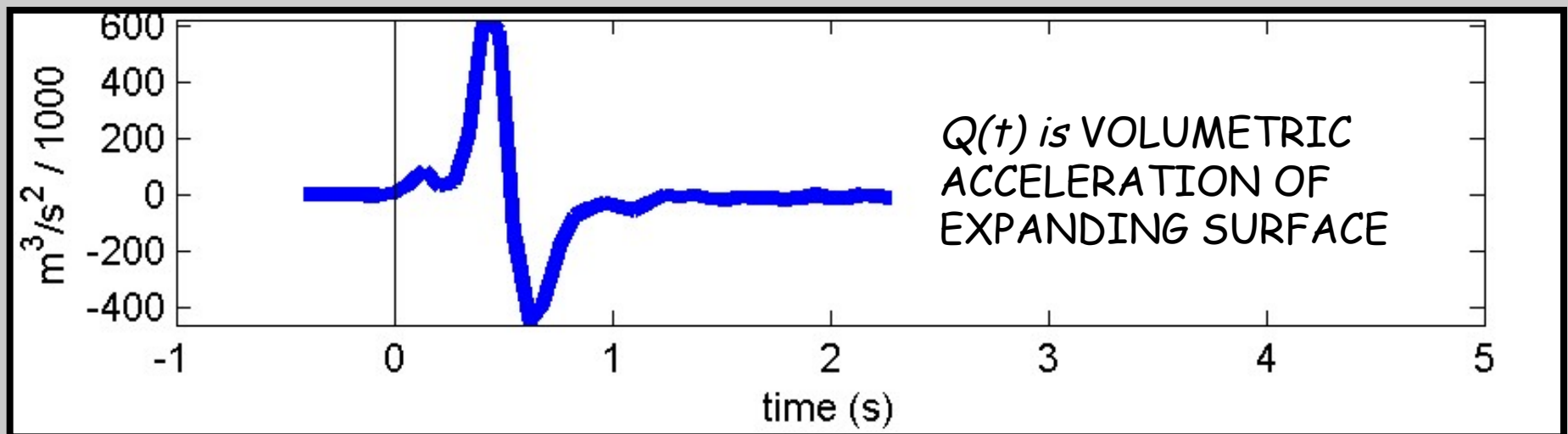

#2 12/31/05 11:44:39

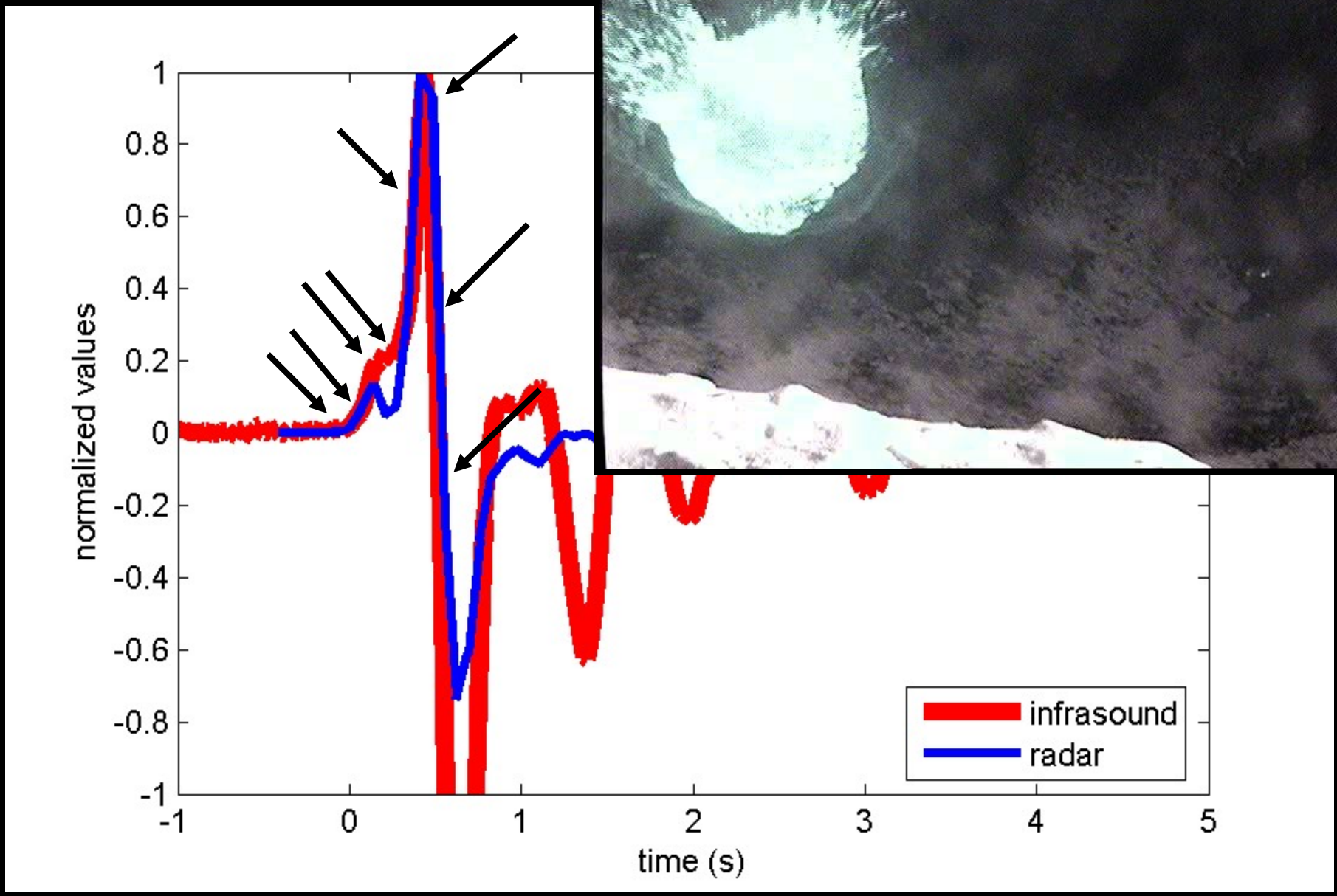

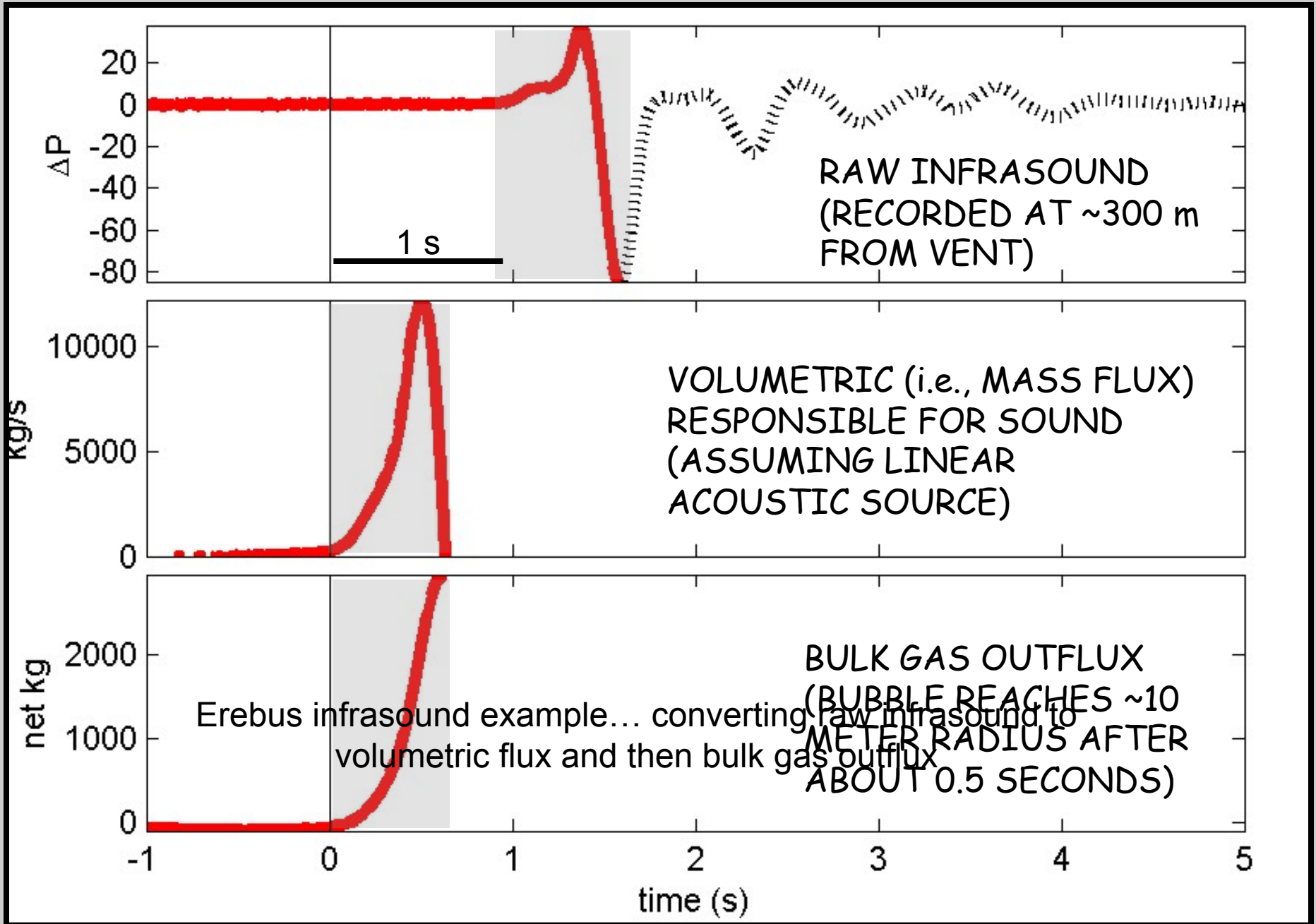



Tungurahua



Erebus

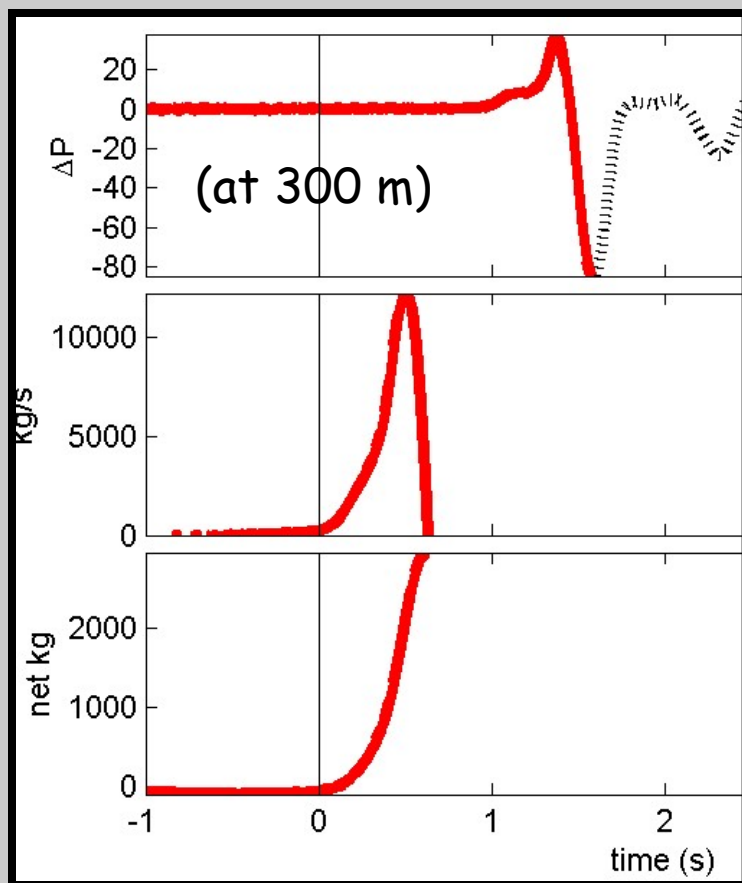

Tungurahua

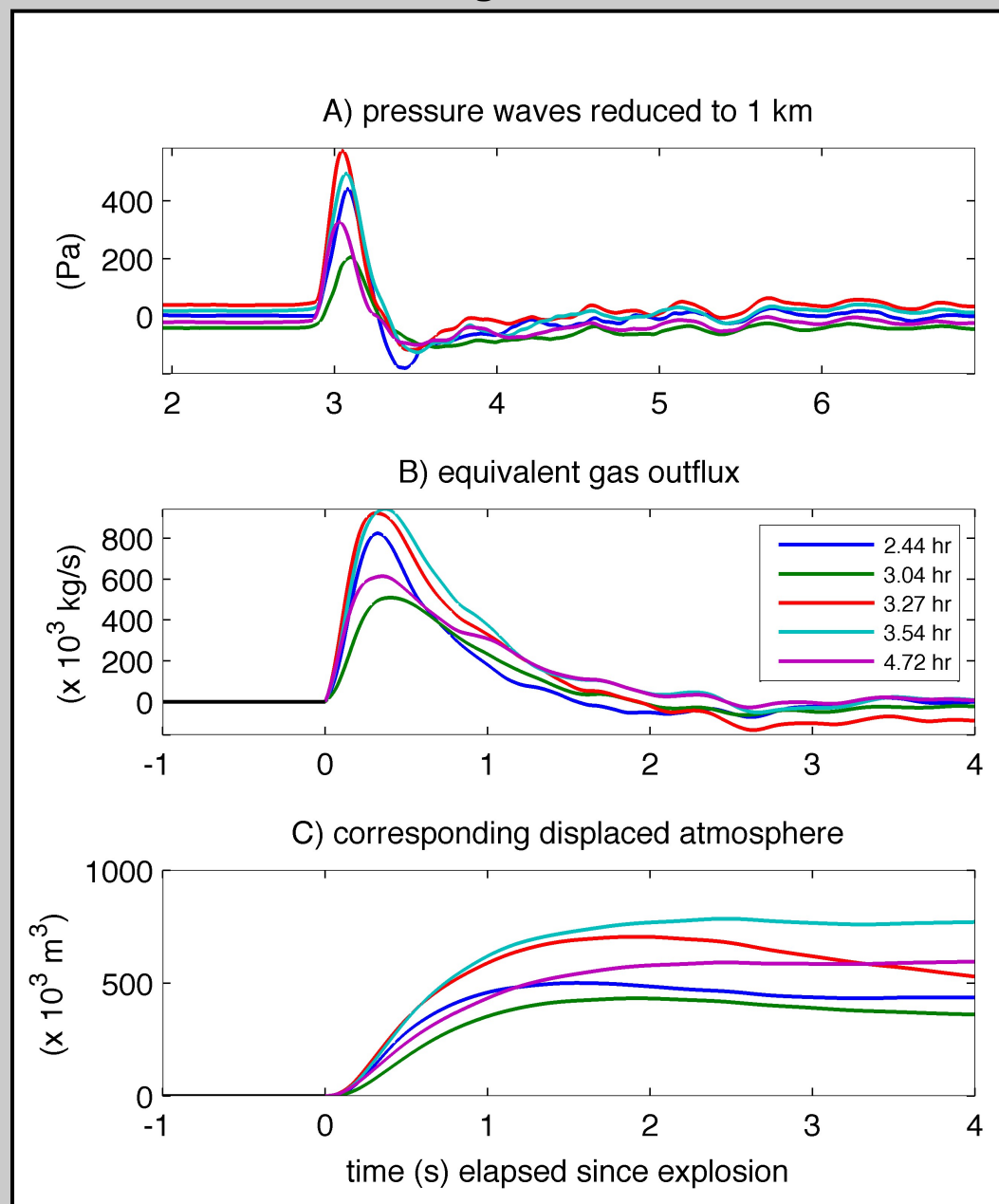



Santiago





SGC

01/01/09 12:57 PM



Vent dimension = ~200 m diameter

Event #1: occurring Jan 002 at 14:16:46









1)

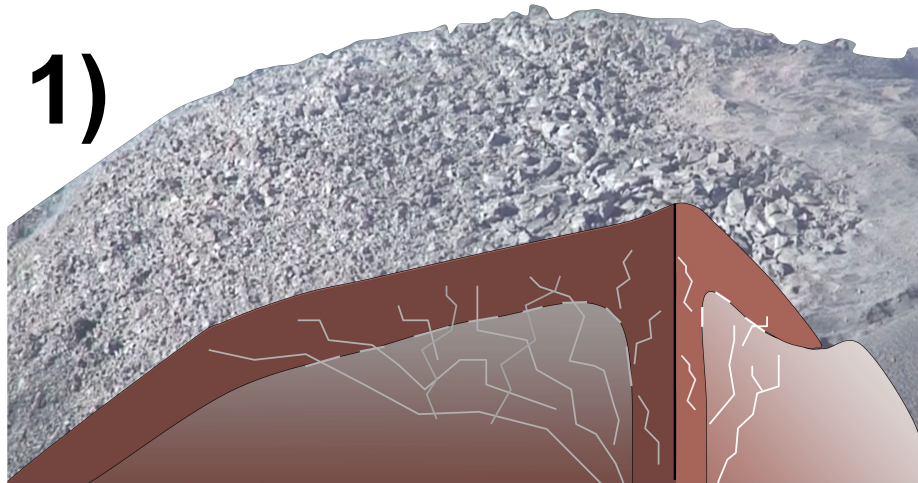

2)

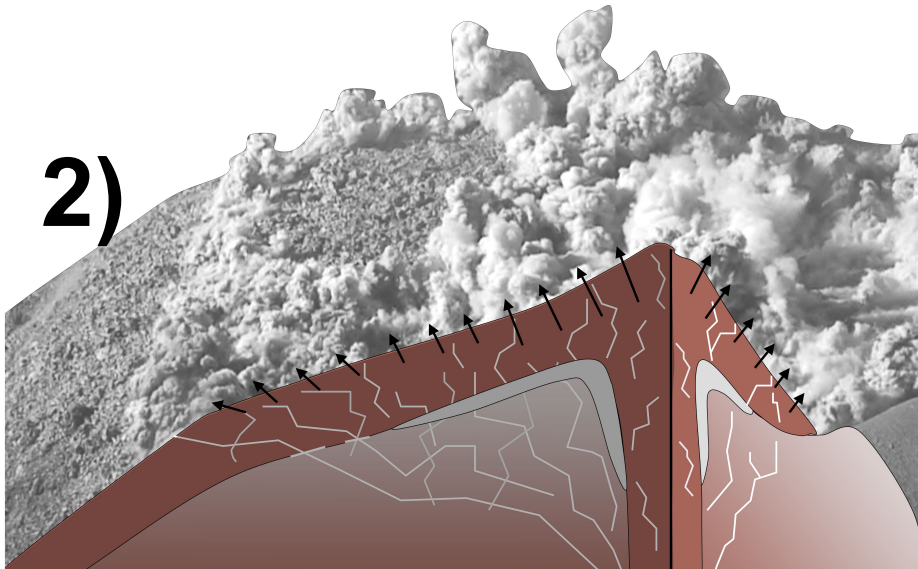

**1) Inter-eruptive interval
(30-60 min):**

Dome is static and is annealed near surface to inhibit surface gas venting. Cracks/voids/foam becomes pressurized without significant movement or inflation evident at surface.

**2) Co-eruptive interval
(~10-60 s in duration):**

Detachment occurs and dome is rapidly "floated upwards". Volatiles vent through "compromised" fracture zones. Low-friction basal contact facilitates lateral slipping.

From Johnson et al., 2008 (Nature)

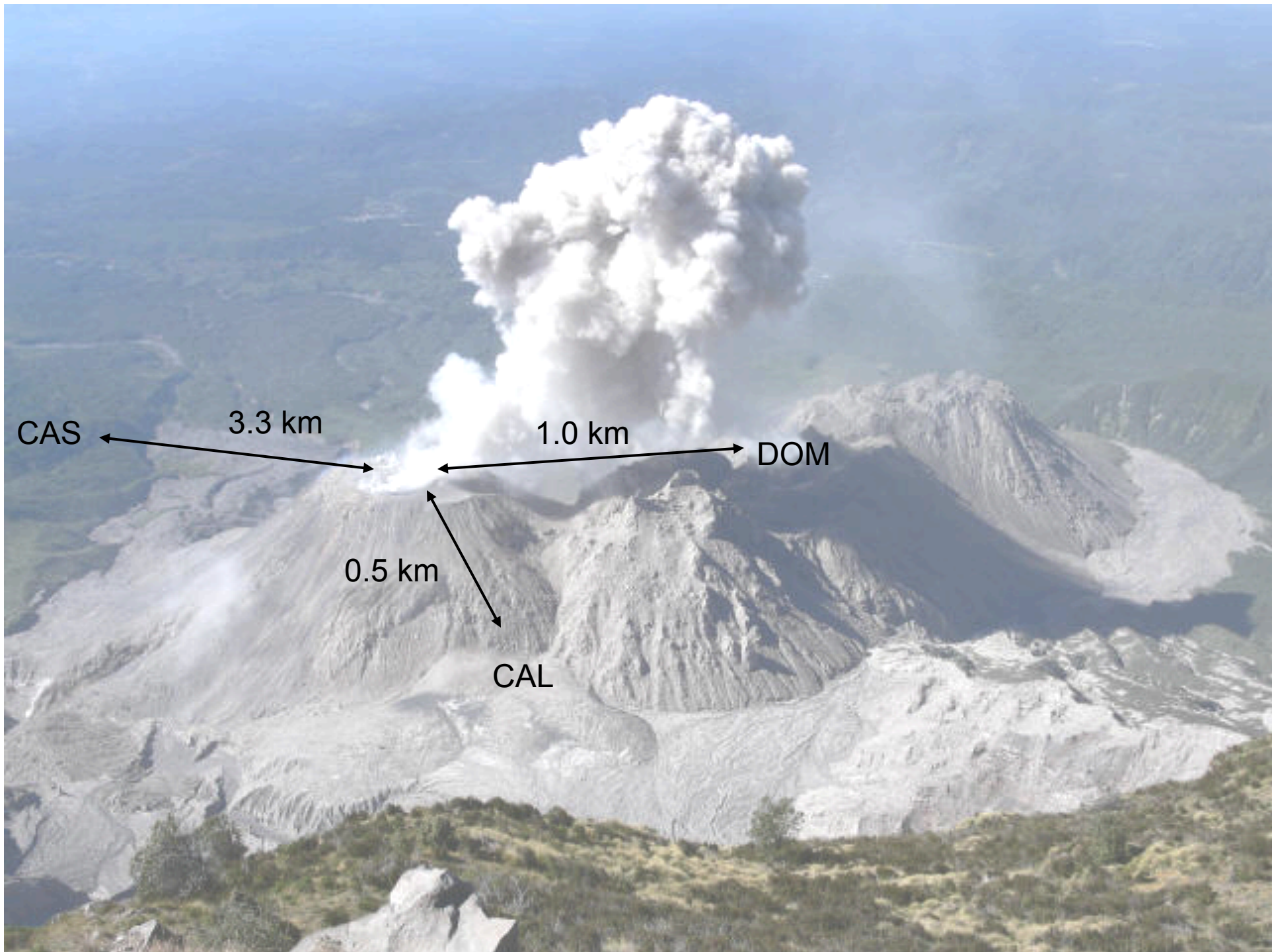

event #1: Jan002 14:16
time elapsed: 0 s

- ▲ 1 m uplift
- ▲ 0.5 m uplift
- ▼ 0.25 m downdrop

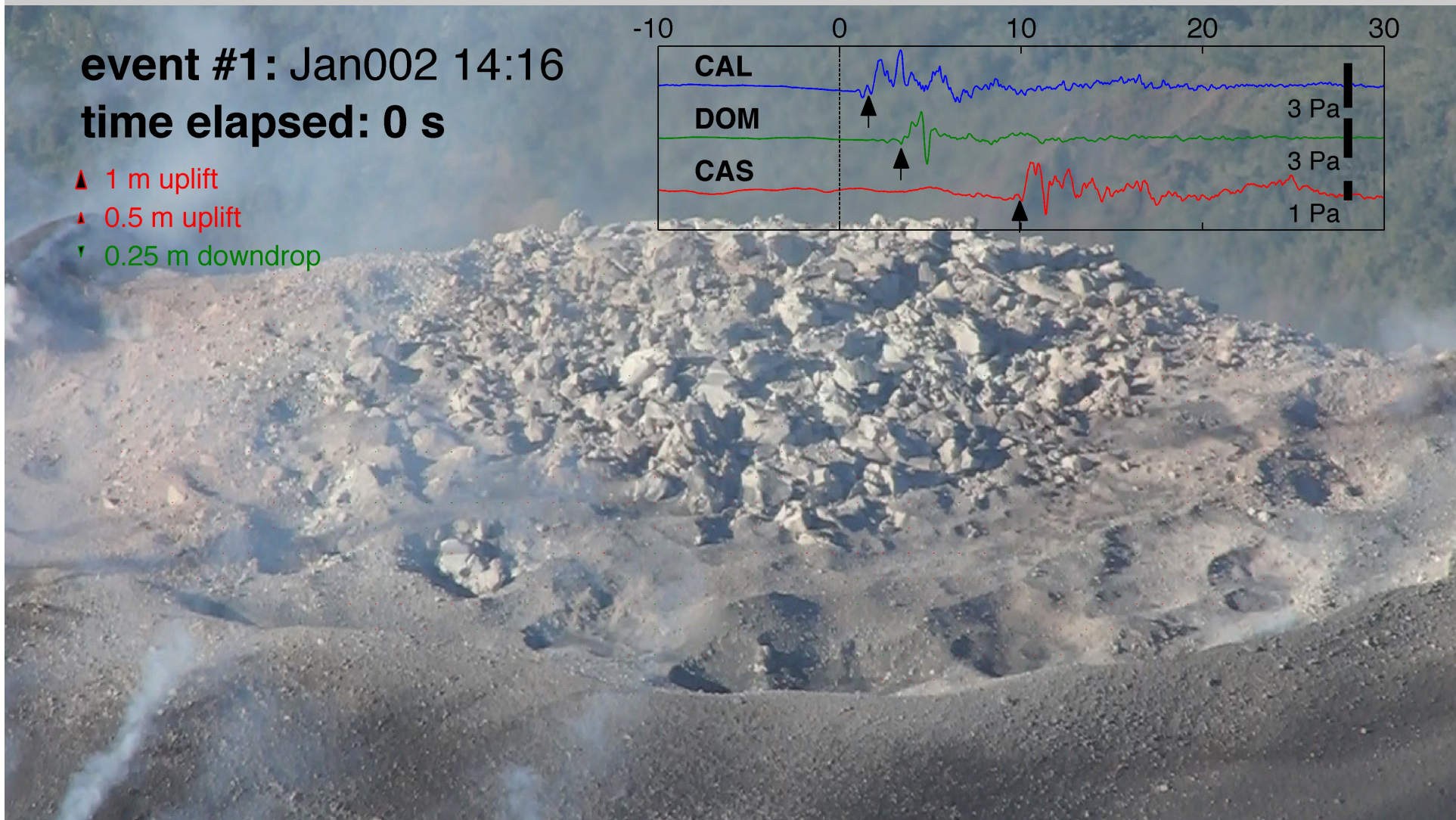
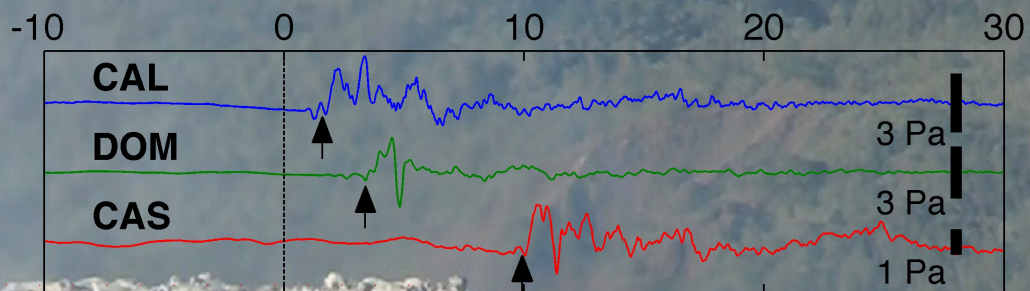

event #1: Jan002 14:16
time elapsed: 0.1 s

- ▲ 1 m uplift
- ▲ 0.5 m uplift
- ▼ 0.25 m downdrop

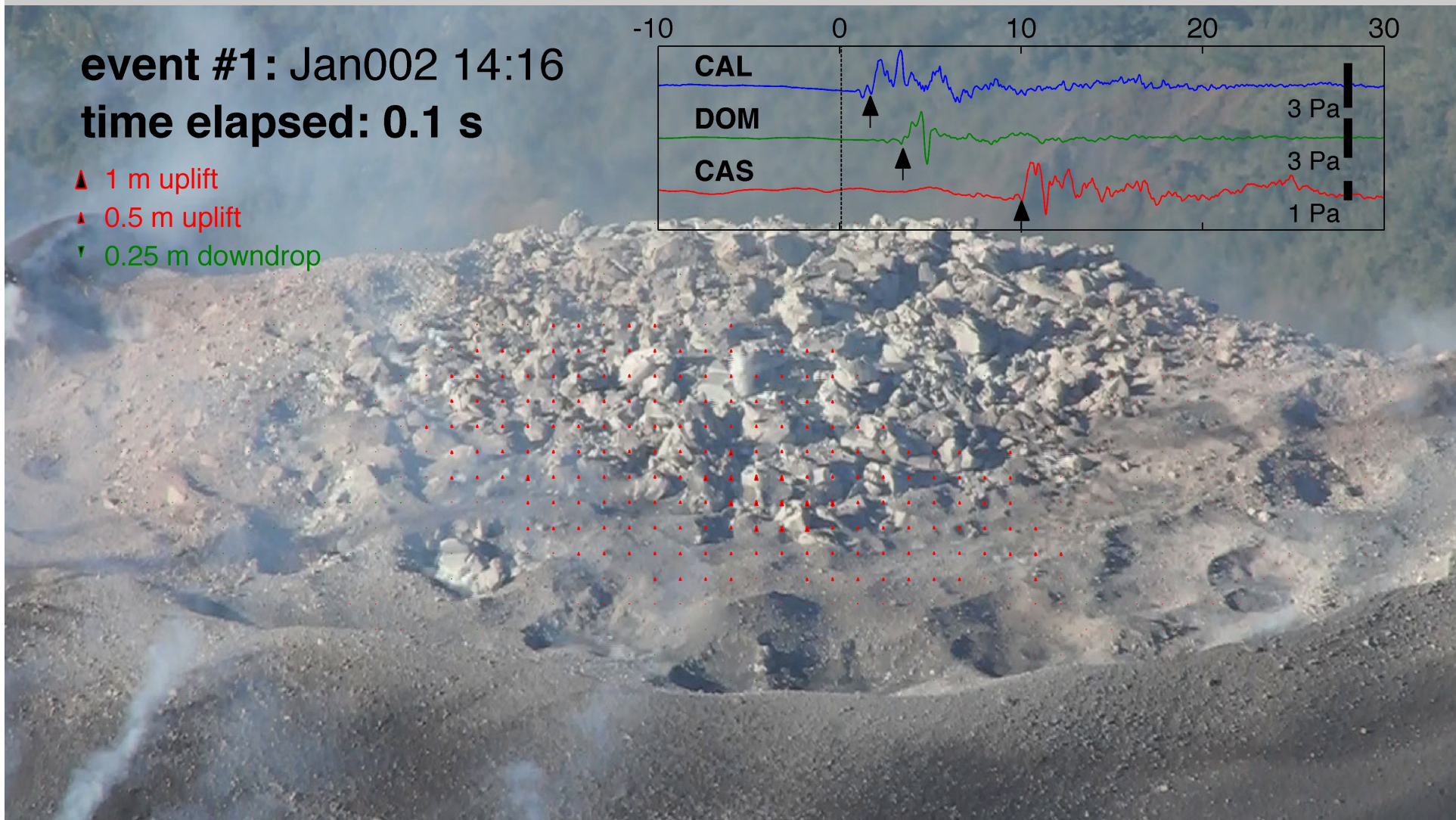
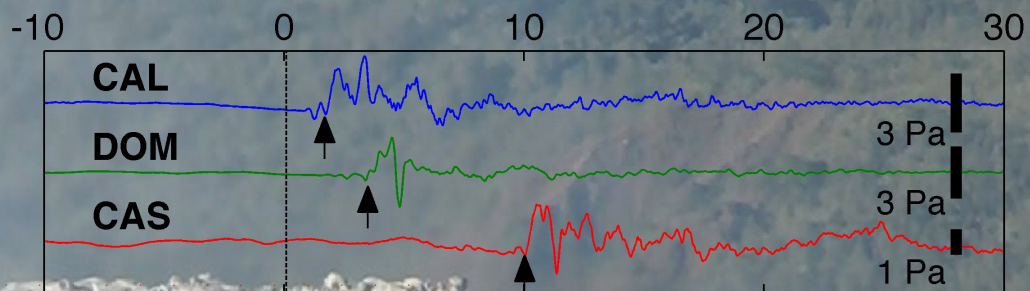

event #1: Jan002 14:16
time elapsed: 0.2 s

- ▲ 1 m uplift
- ▲ 0.5 m uplift
- ▼ 0.25 m downdrop

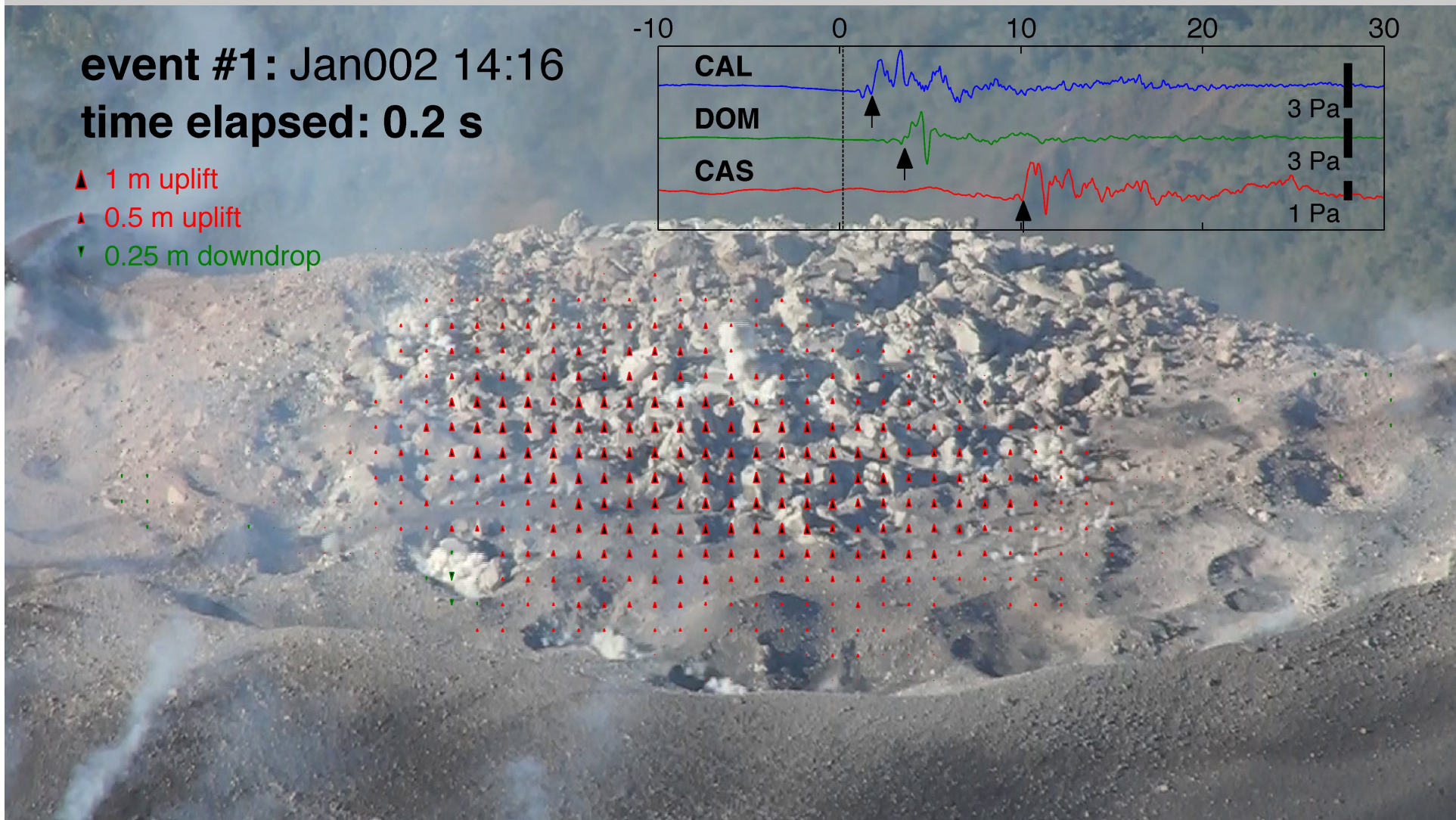
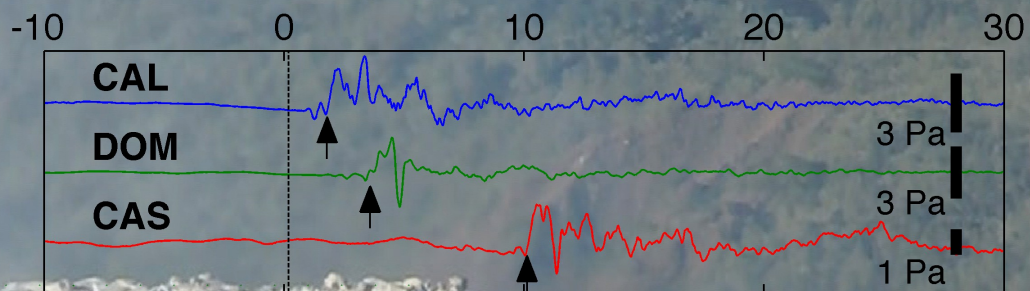

event #1: Jan002 14:16

time elapsed: 0.3 s

- ▲ 1 m uplift
- ▲ 0.5 m uplift
- ▼ 0.25 m downdrop

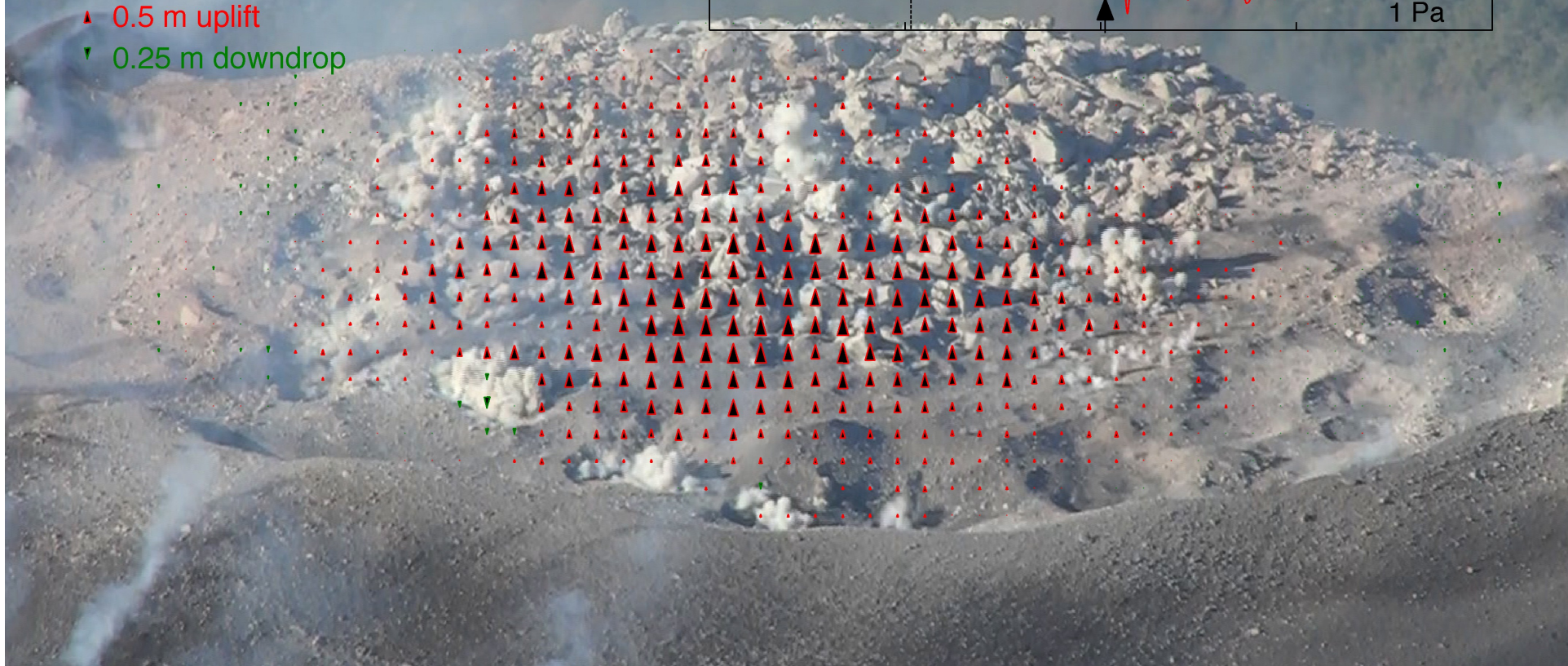
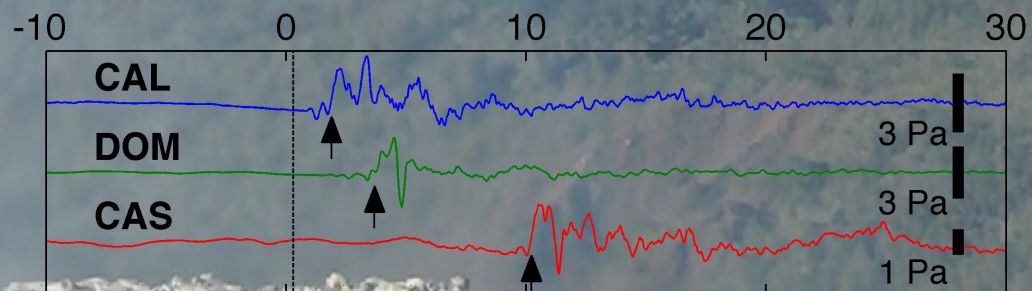

event #1: Jan002 14:16

time elapsed: 0.3 s

- ▲ 1 m uplift
- ▲ 0.5 m uplift
- ▼ 0.25 m downdrop

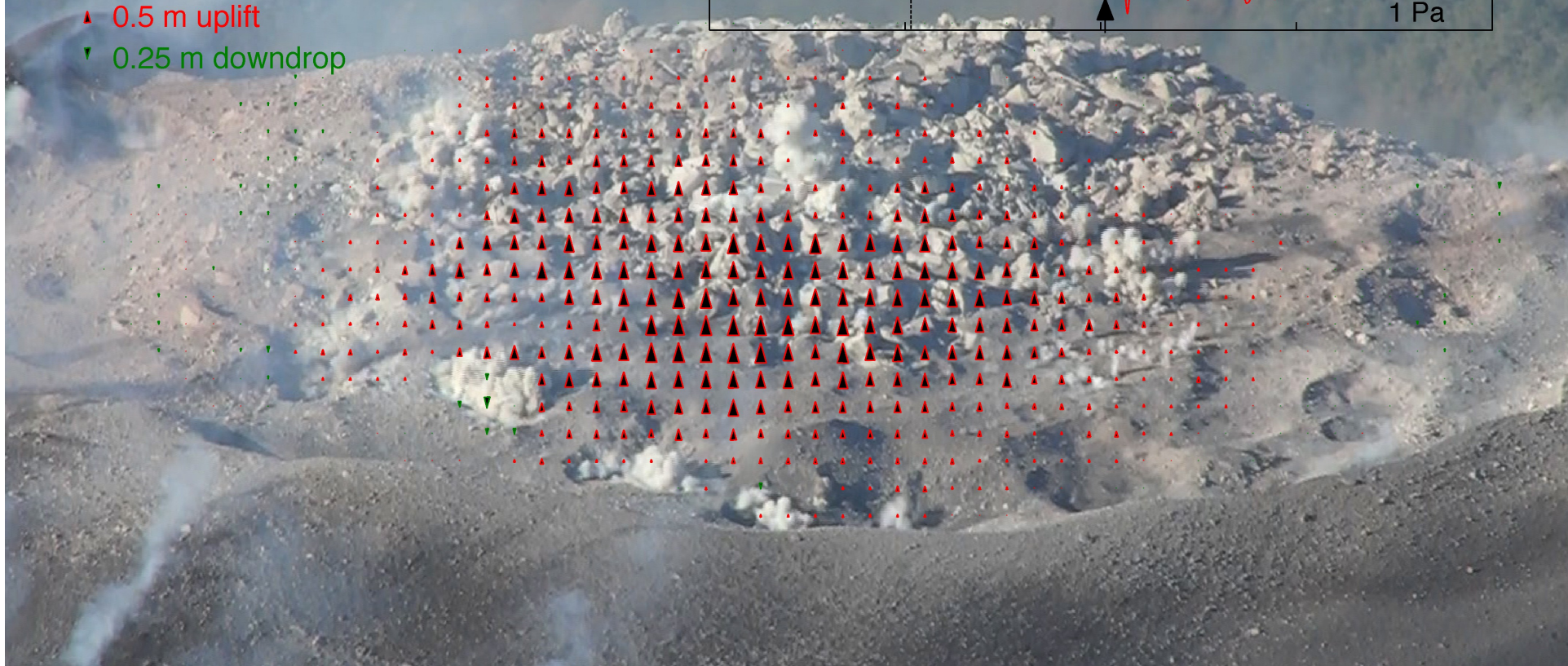
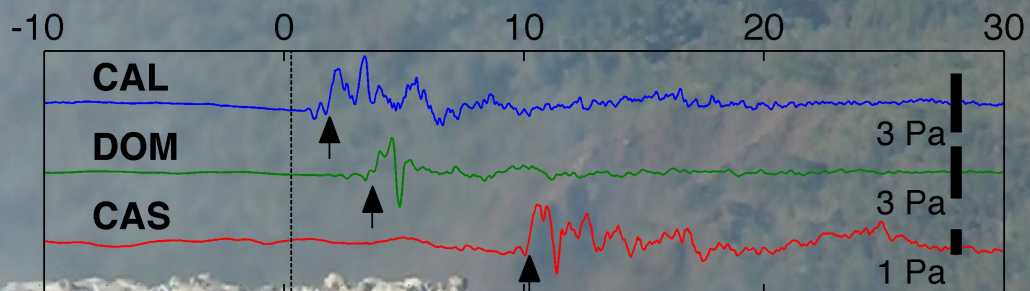

event #1: Jan002 14:16
time elapsed: 0.4 s

- ▲ 1 m uplift
- ▲ 0.5 m uplift
- ▼ 0.25 m downdrop

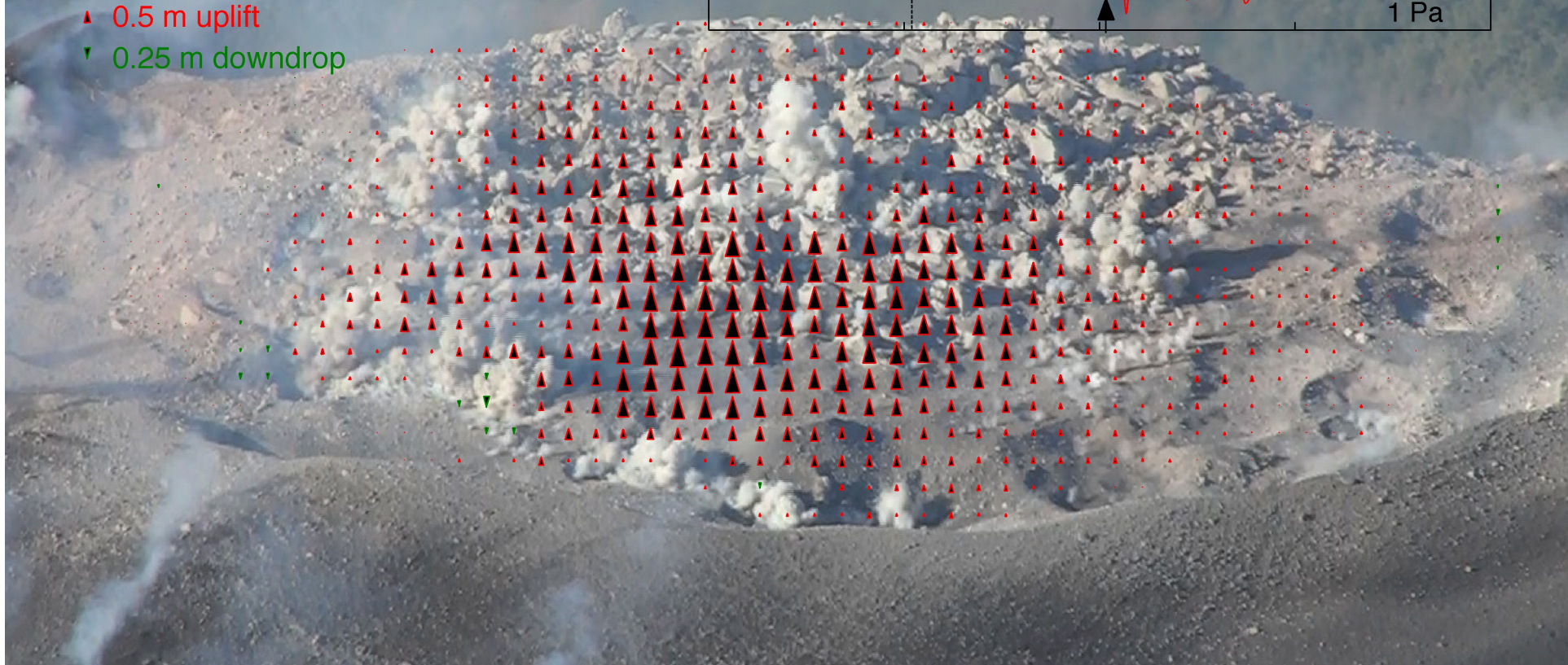
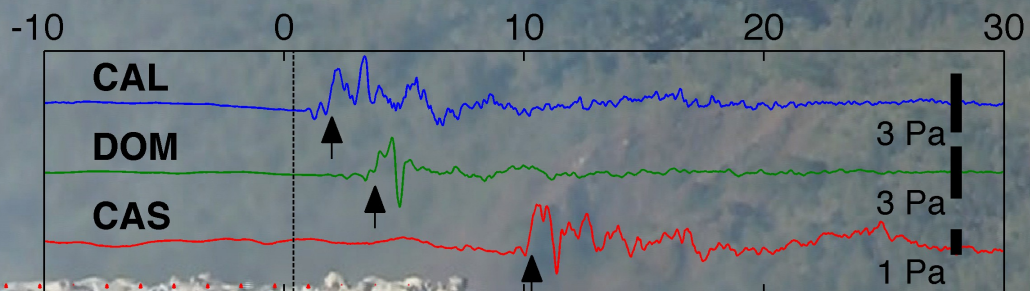

event #1: Jan002 14:16

time elapsed: 0.5 s

- ▲ 1 m uplift
- ▲ 0.5 m uplift
- ▼ 0.25 m downdrop

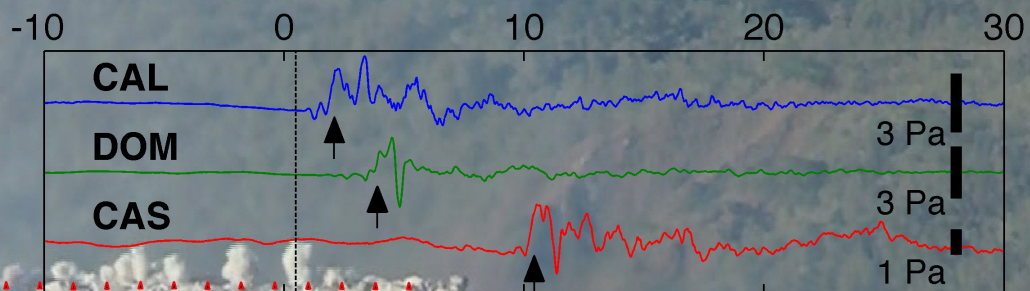

event #1: Jan002 14:16

time elapsed: 0.6 s

▲ 1 m uplift

▲ 0.5 m uplift

▼ 0.25 m downdrop

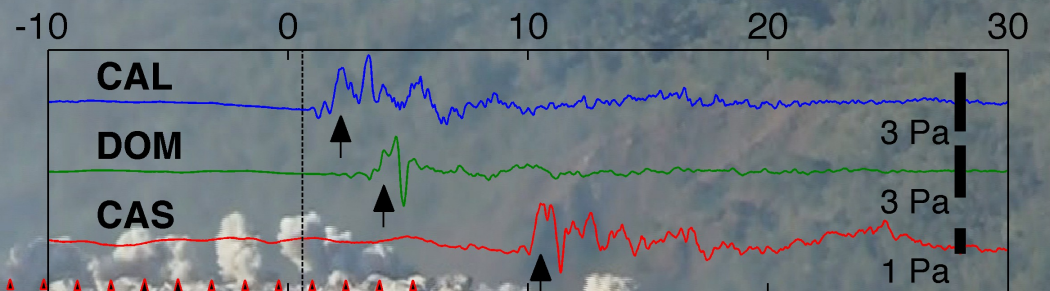

event #1: Jan002 14:16

time elapsed: 0.7 s

- ▲ 1 m uplift
- ▲ 0.5 m uplift
- ▼ 0.25 m downdrop

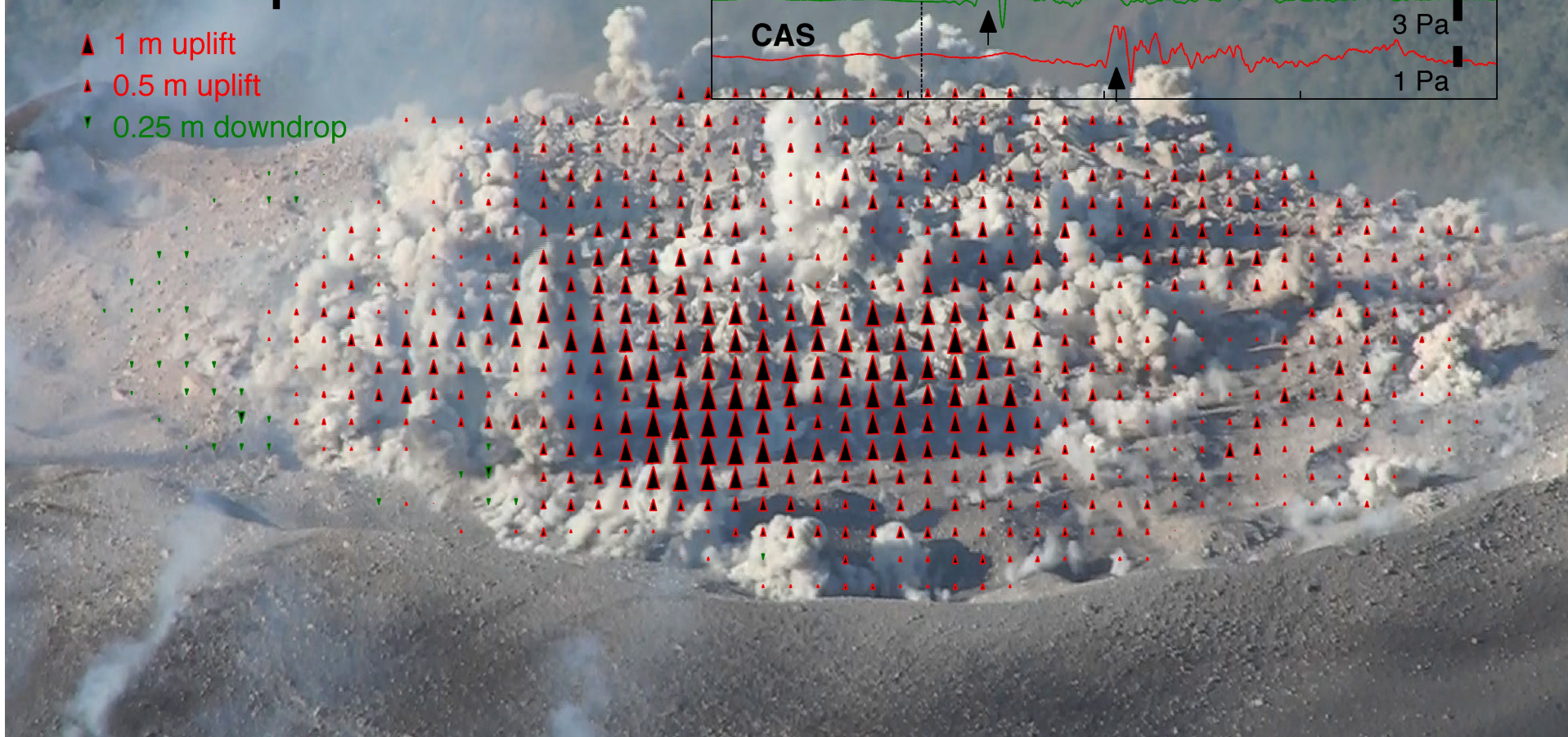
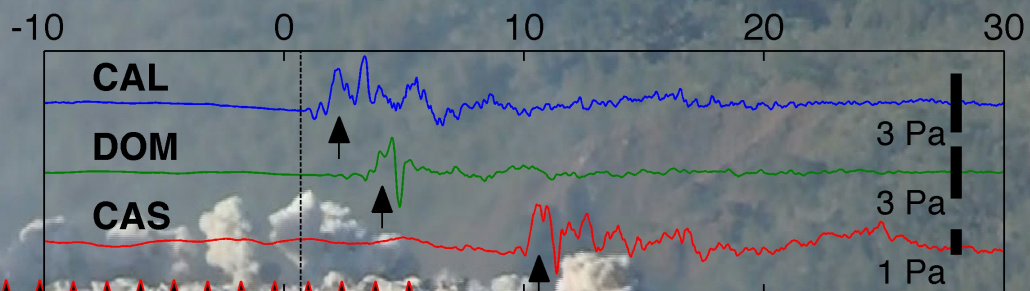

event #1: Jan002 14:16
time elapsed: 0.8 s

- ▲ 1 m uplift
- ▲ 0.5 m uplift
- ▼ 0.25 m downdrop

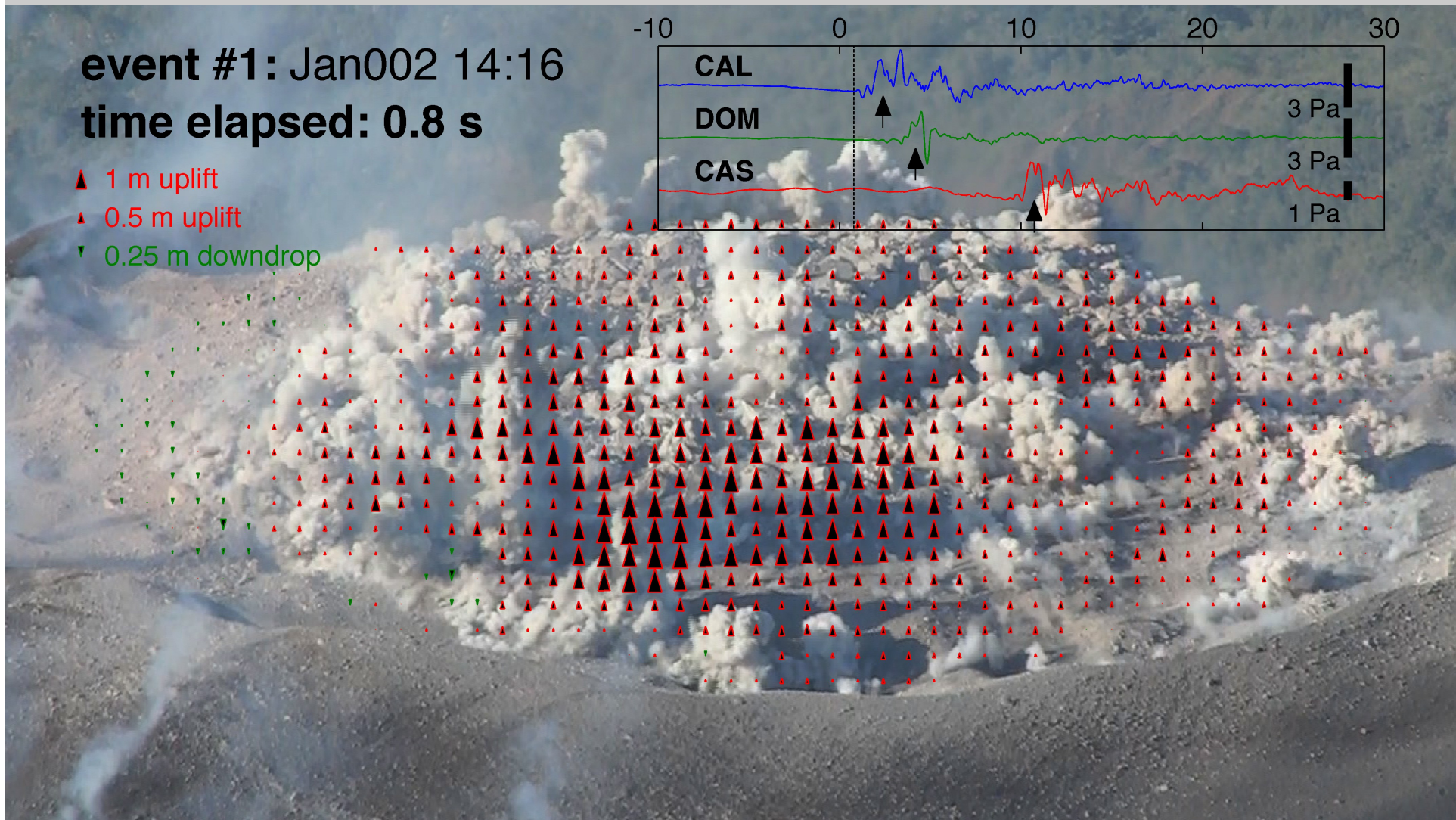
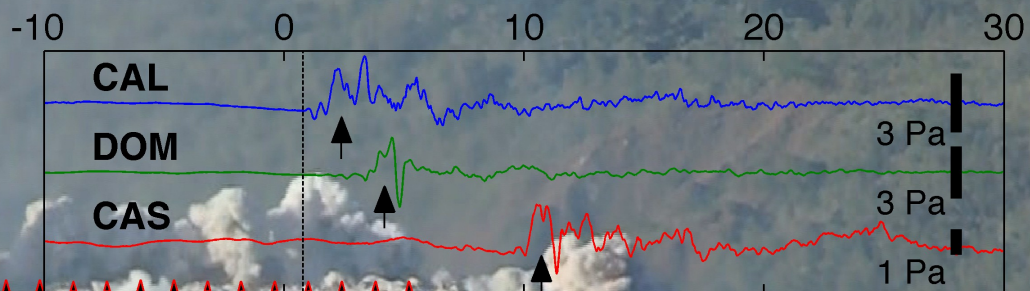

event #1: Jan002 14:16
time elapsed: 0.8 s

- ▲ 1 m uplift
- ▲ 0.5 m uplift
- ▼ 0.25 m downdrop

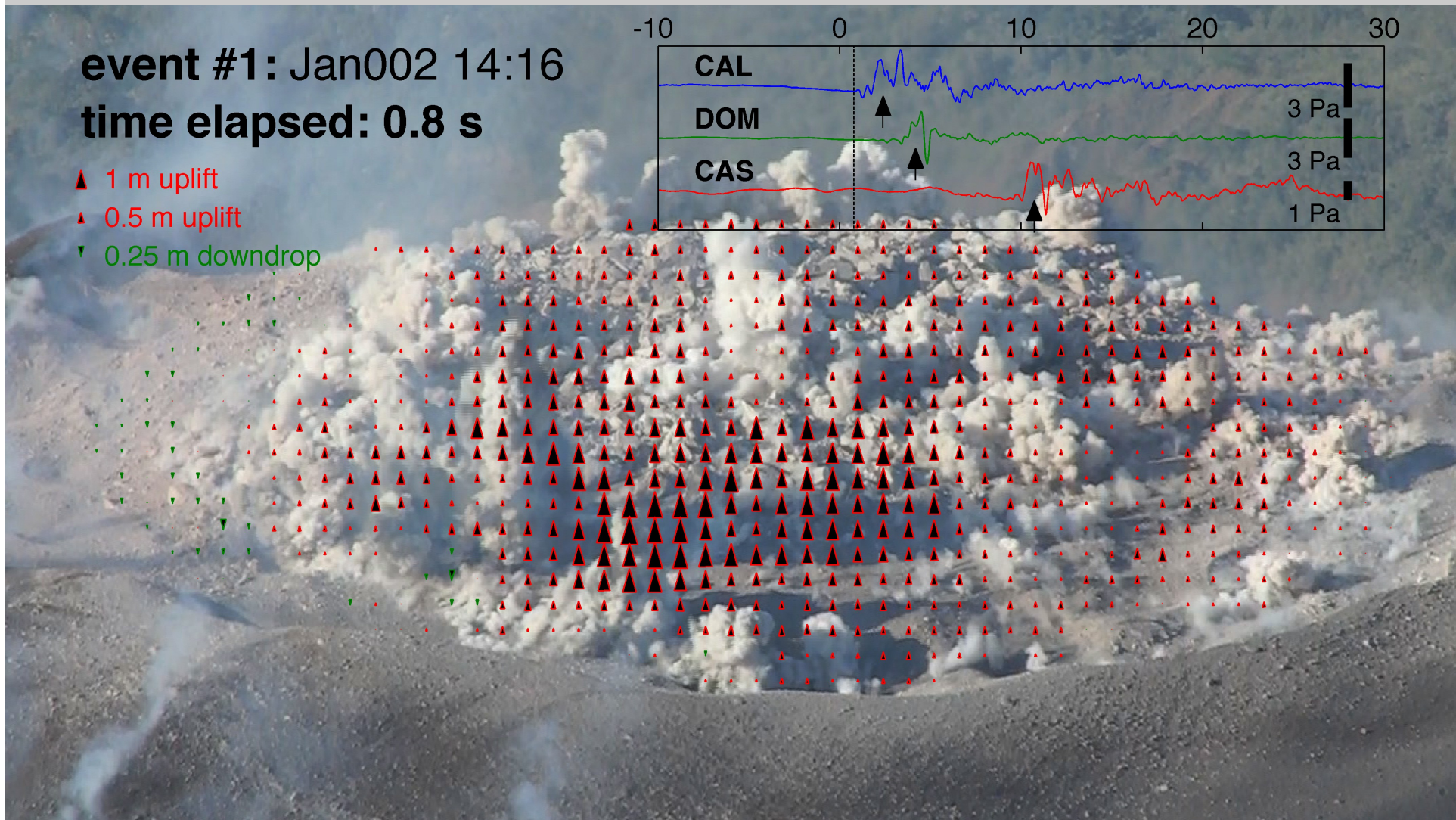
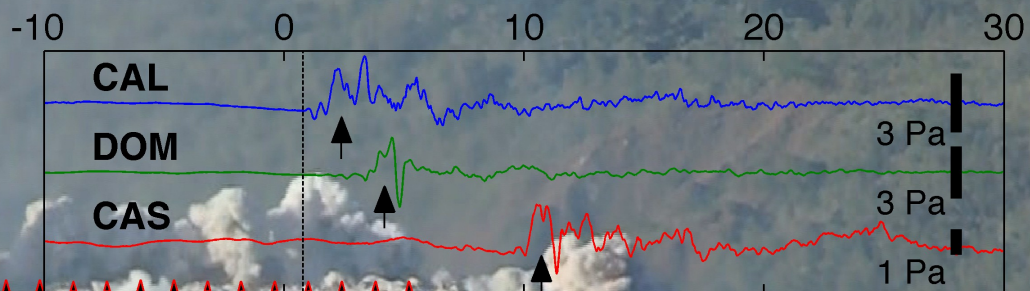

event #1: Jan002 14:16
time elapsed: 0.9 s

- ▲ 1 m uplift
- ▲ 0.5 m uplift
- ▼ 0.25 m downdrop

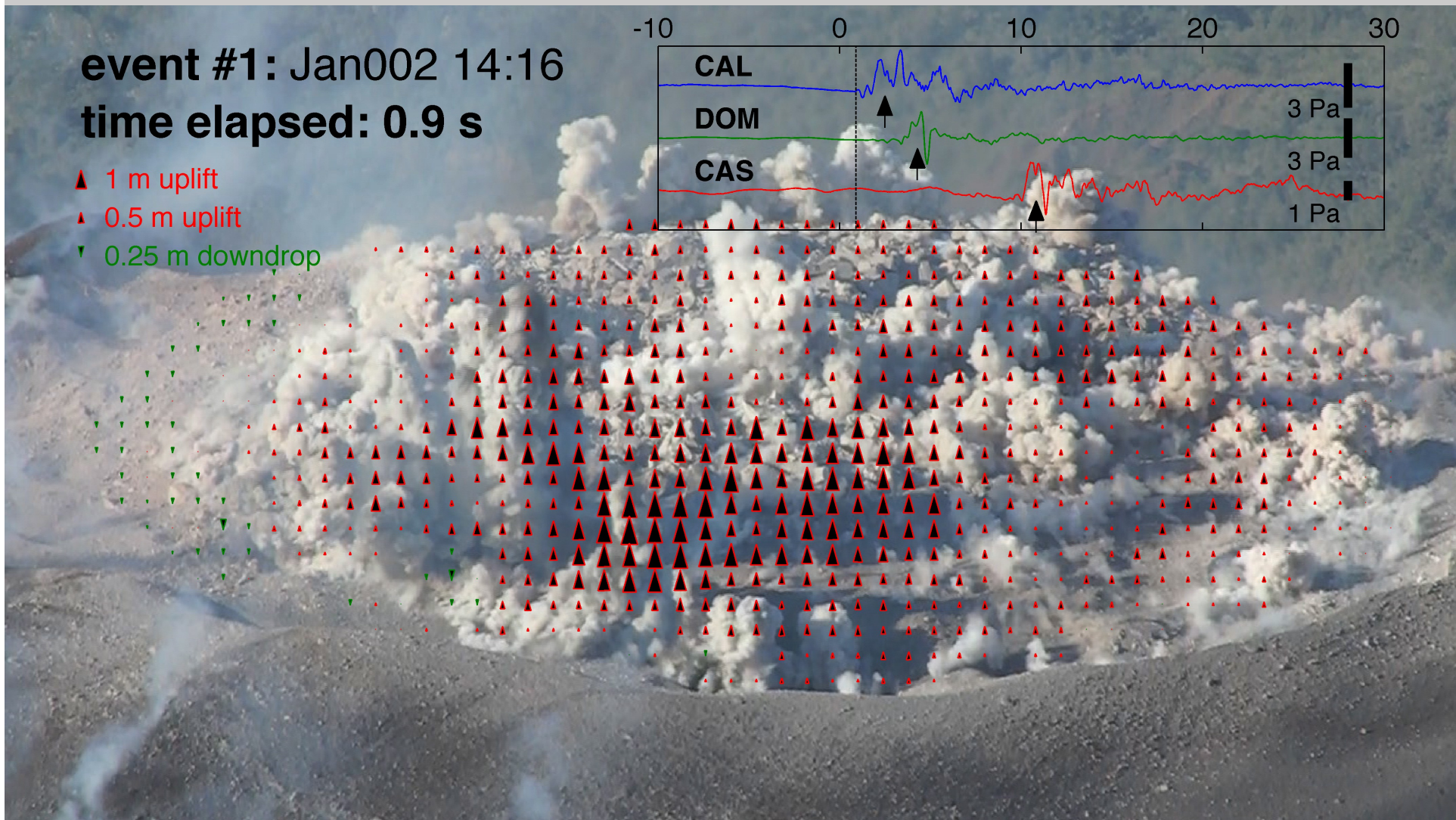
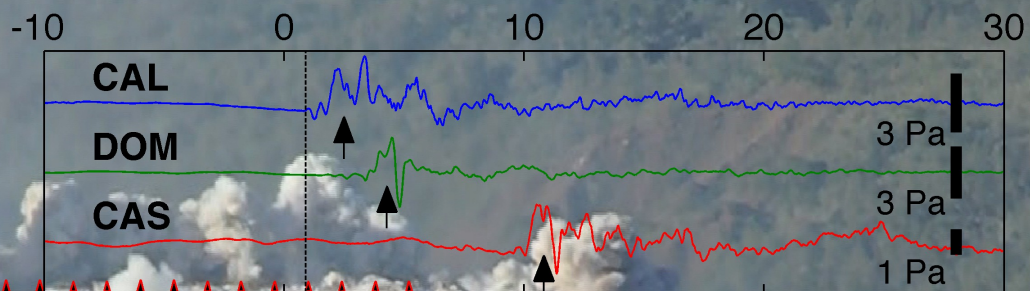

event #1: Jan002 14:16

time elapsed: 1 s

- ▲ 1 m uplift
- ▲ 0.5 m uplift
- ▼ 0.25 m downdrop

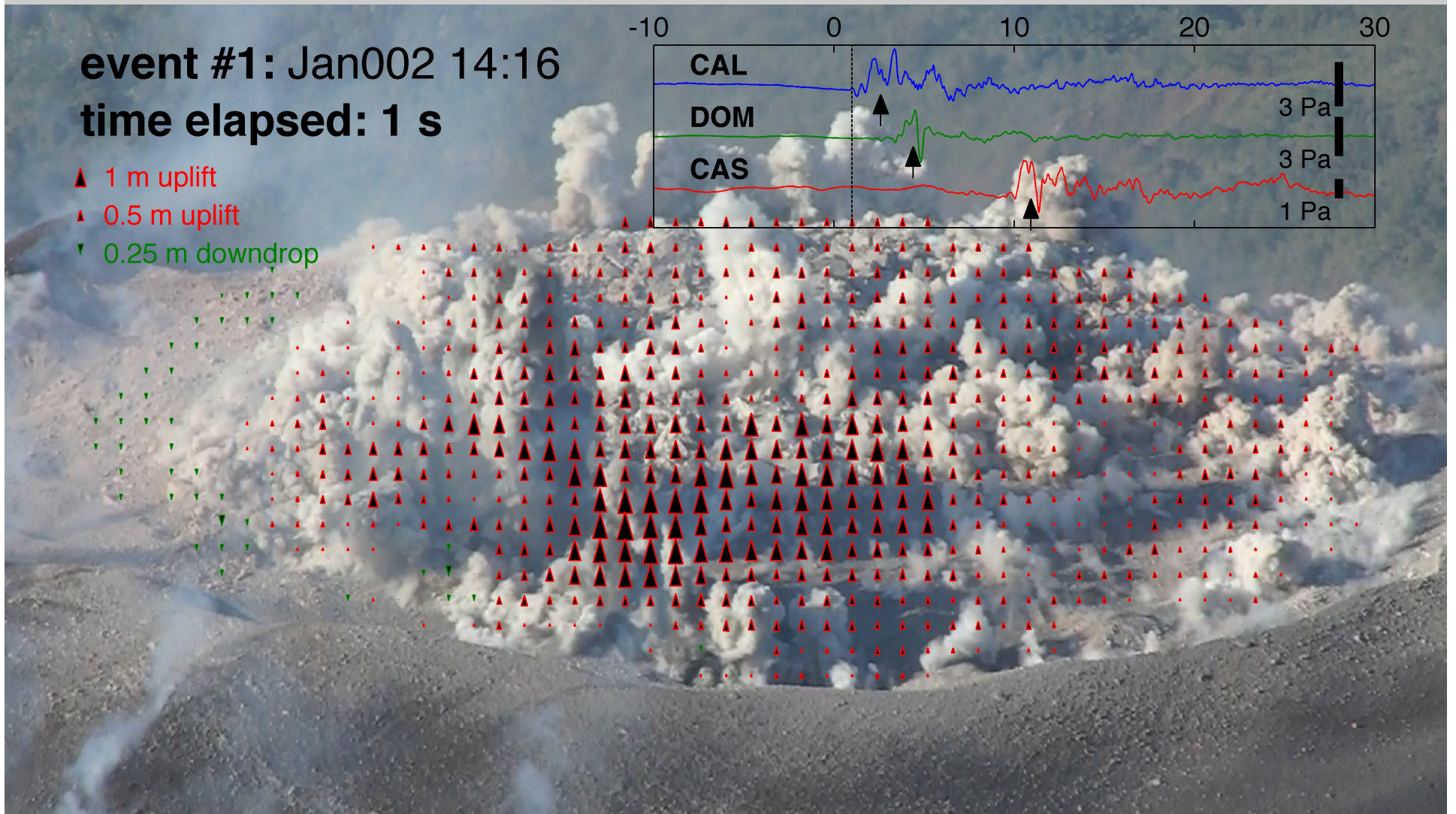
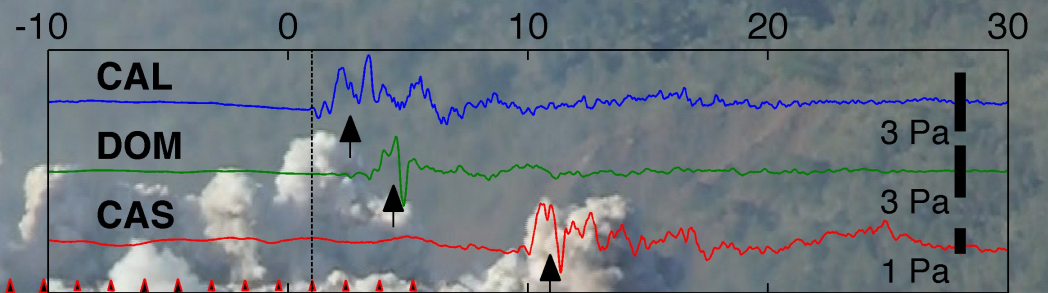

event #1: Jan002 14:16

time elapsed: 0 s

- ▲ 1 m uplift
- ▲ 0.5 m uplift
- ▼ 0.25 m downdrop

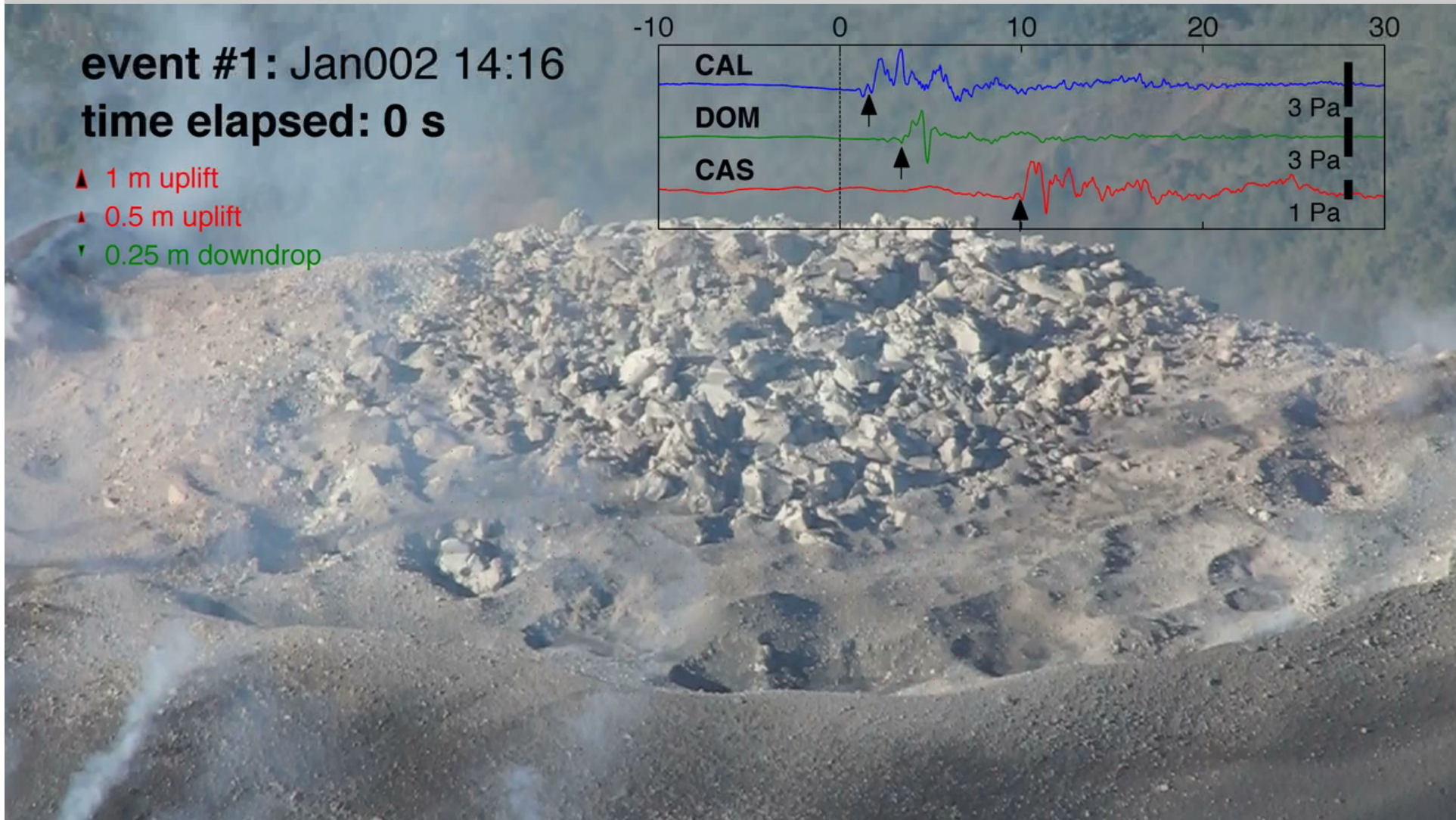
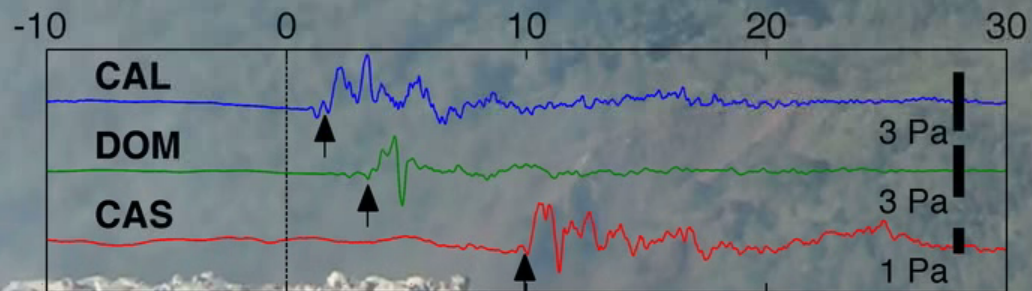

event #2: Jan002 13:54
time elapsed: 0 s

- ▲ 1 m uplift
- ▲ 0.5 m uplift
- ▼ 0.25 m downdrop

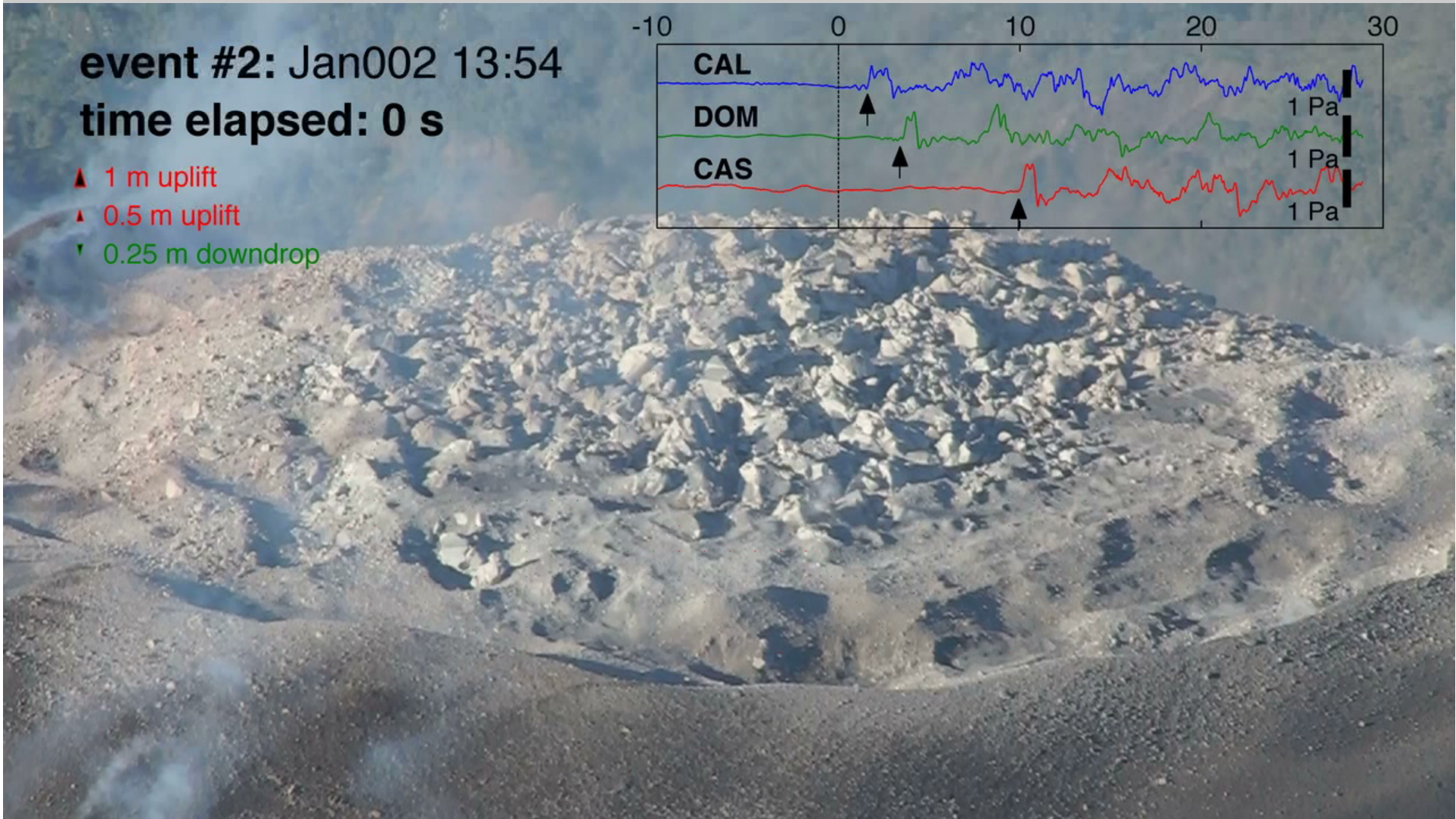
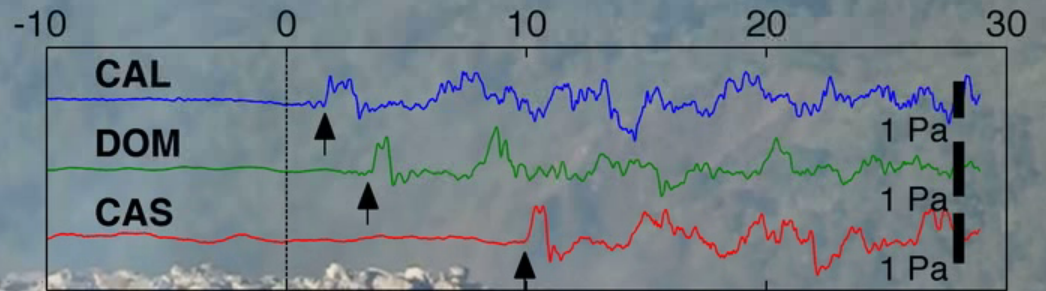



Villarrica



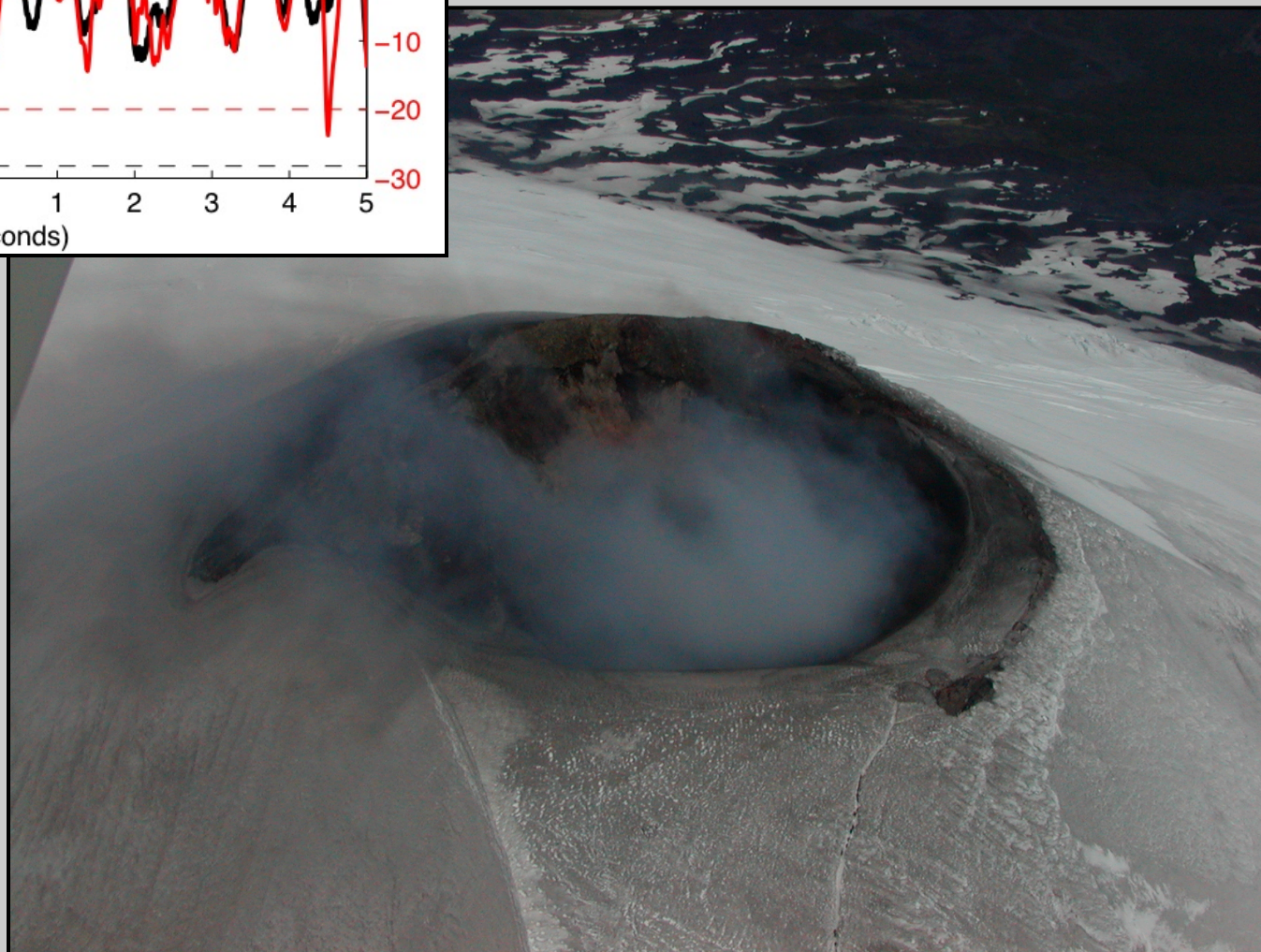
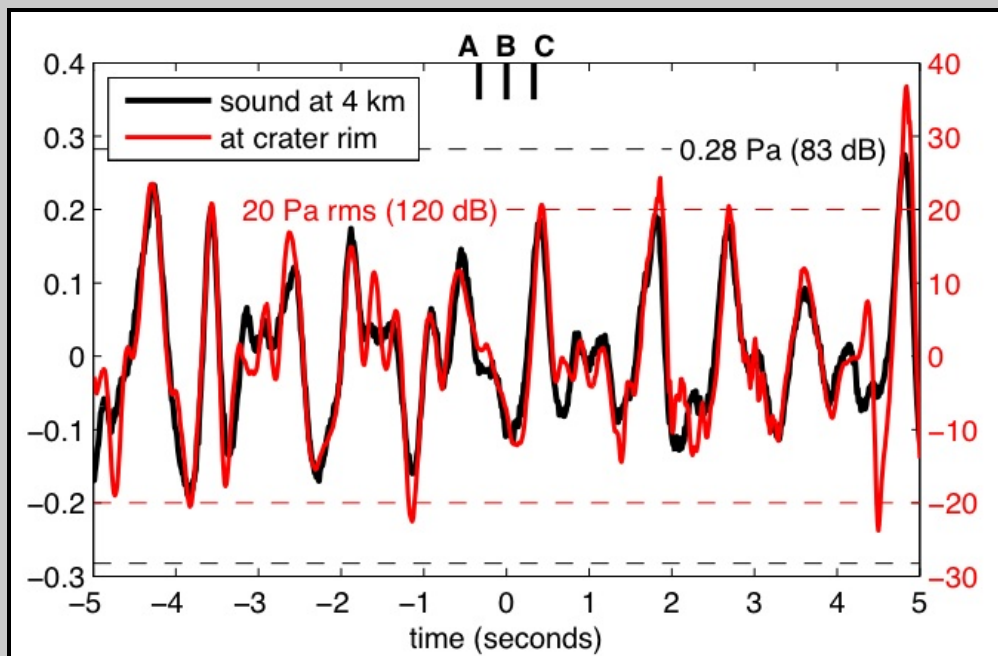









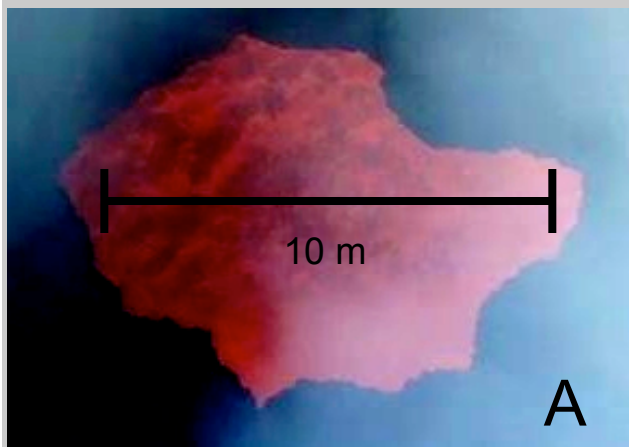
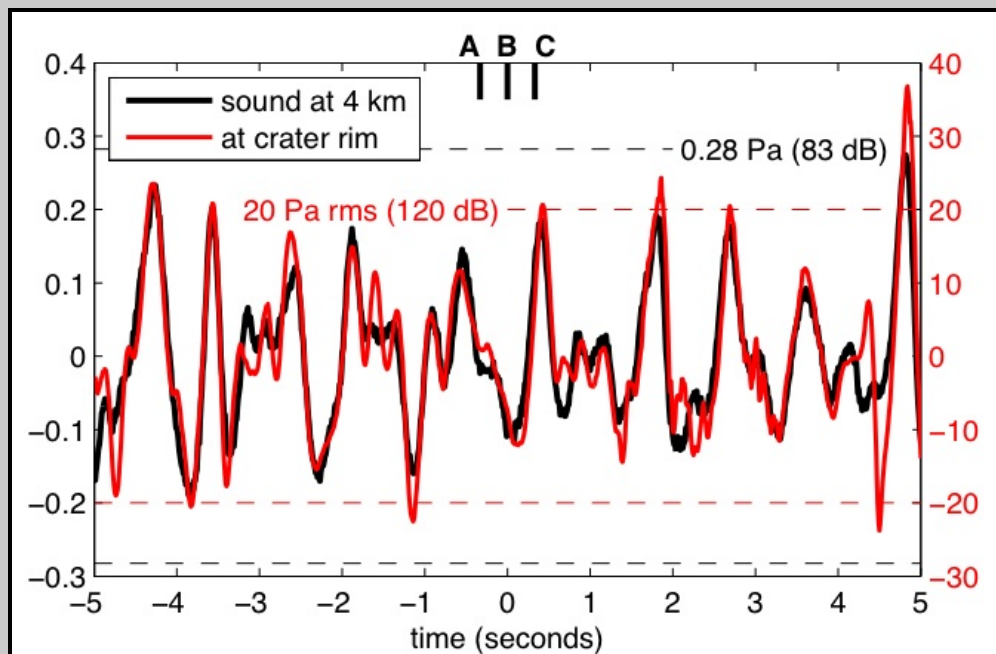

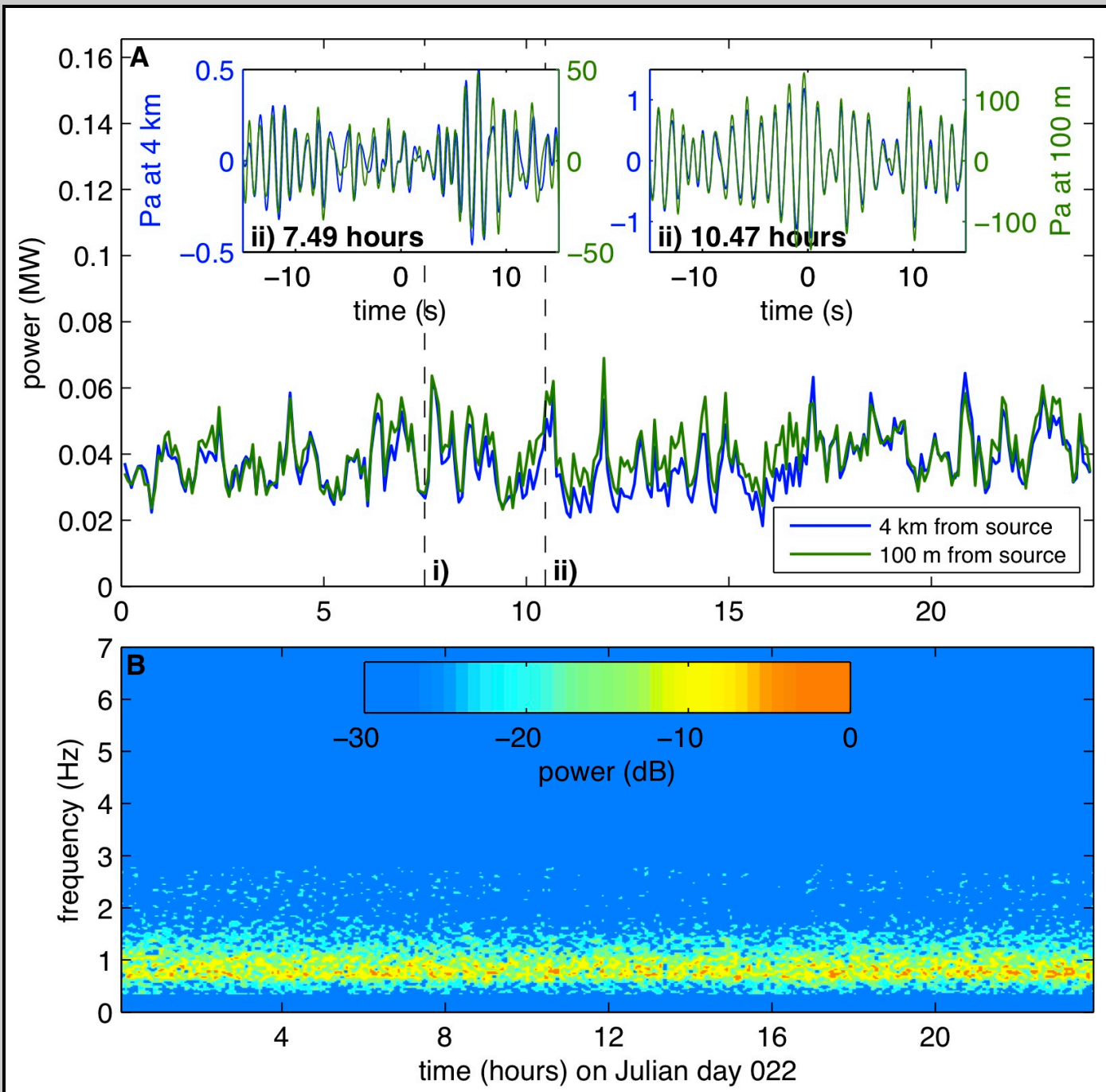

Helmholtz Resonance for short pipe case:

$$f = \frac{c}{2\pi} \sqrt{\frac{\pi r}{1.7V}}$$

f is resonance frequency = ~0.8 Hz

c is sound velocity = 515 m/s (Fee et al., 2010)

A is pipe cross sectional area = ~75 m²

r is skylight radius (4-5 m)

L is pipe length = **NOT IMPORTANT**

V is cavity volume (unknown)

D = diameter of cavity volume = 60-70 m

Solving for volume:

$$V = \frac{\pi r}{1.7} \left(\frac{c}{2\pi f} \right)^2 = \frac{\pi D^2}{4} H$$

V = 90,000 m³ and *H* = ~25 m

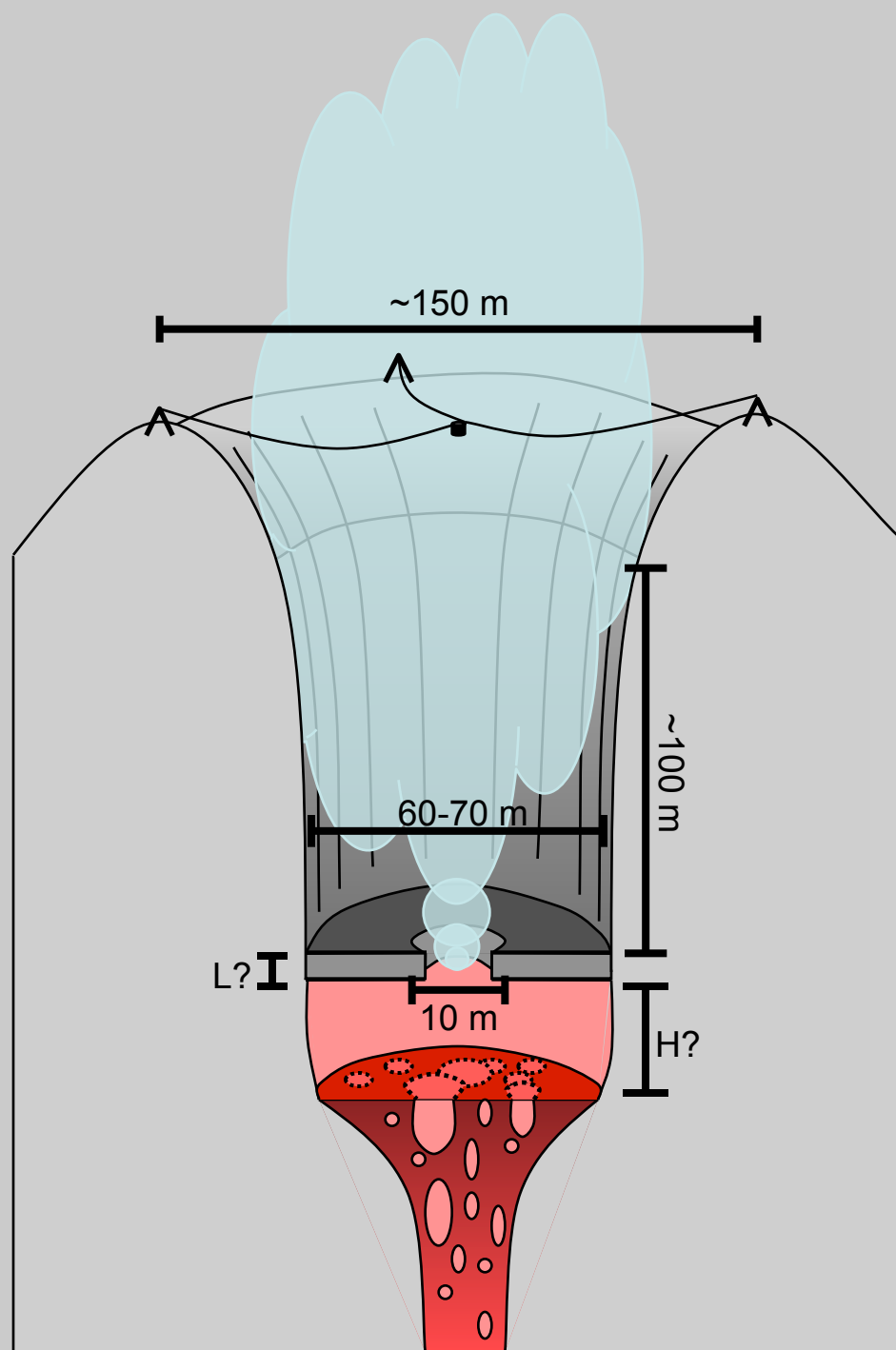

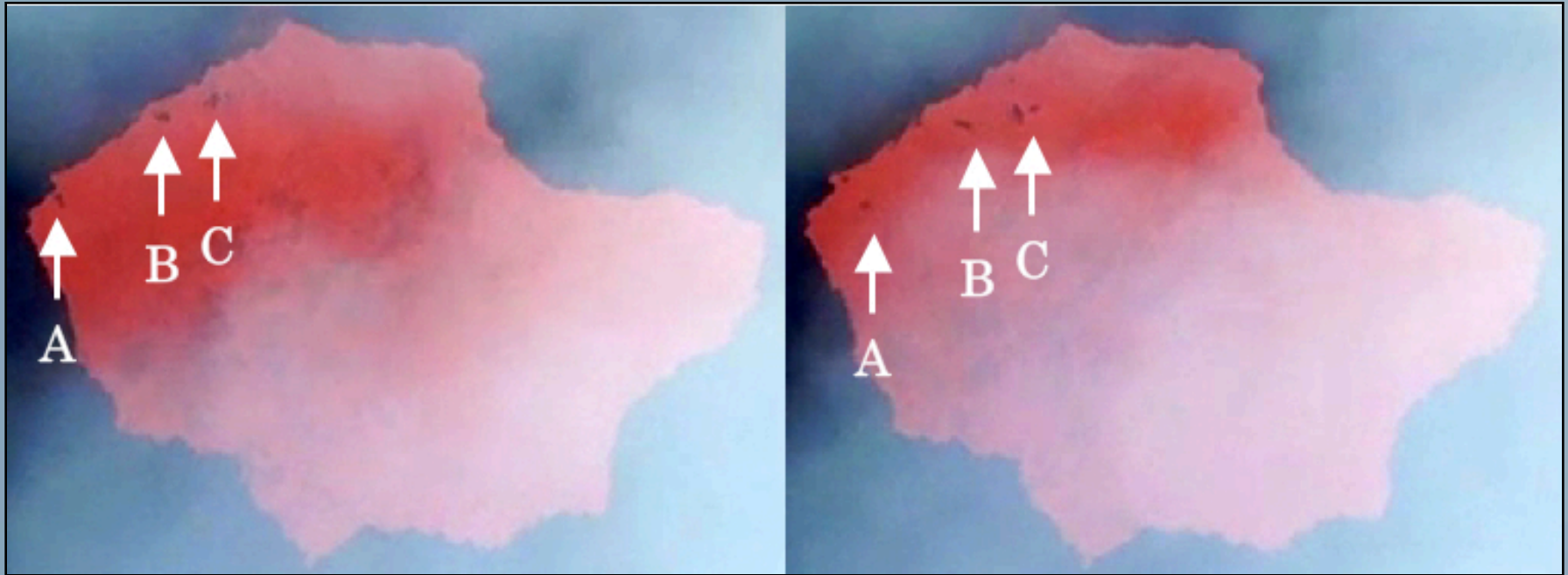

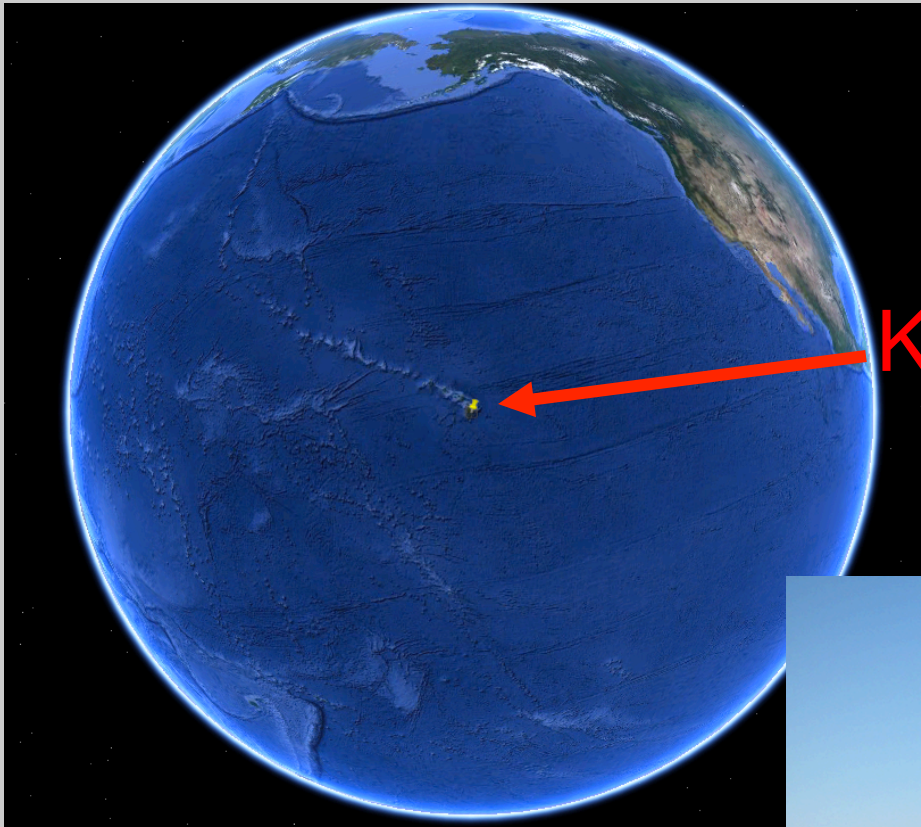

Kilauea





 USGS

A) Tungurahua 2009: Julian Day 165

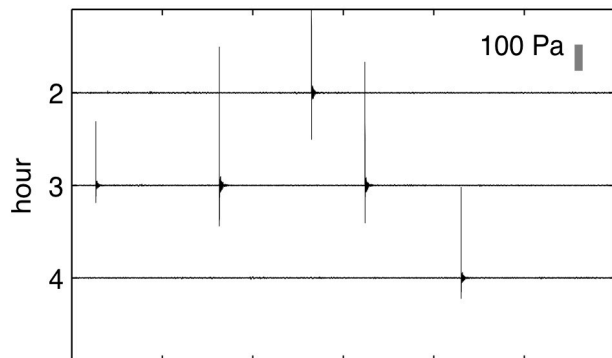

B) Santiaguito 2009: Julian Day 003

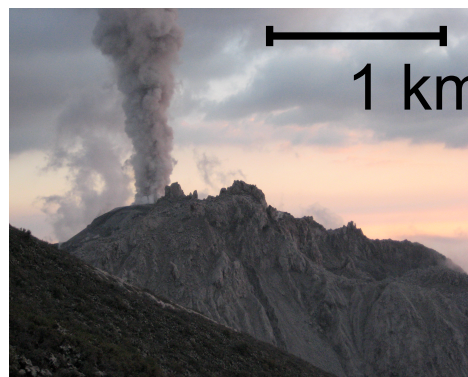
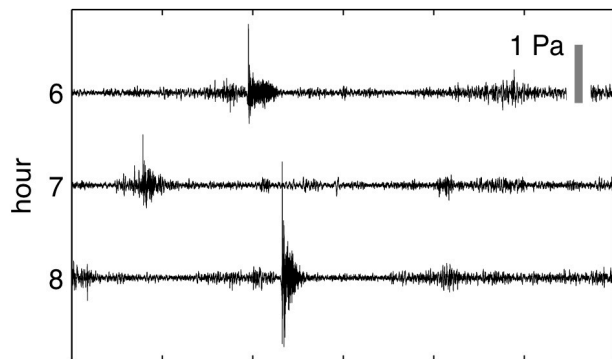

C) Villarrica 2010: Julian Day 022

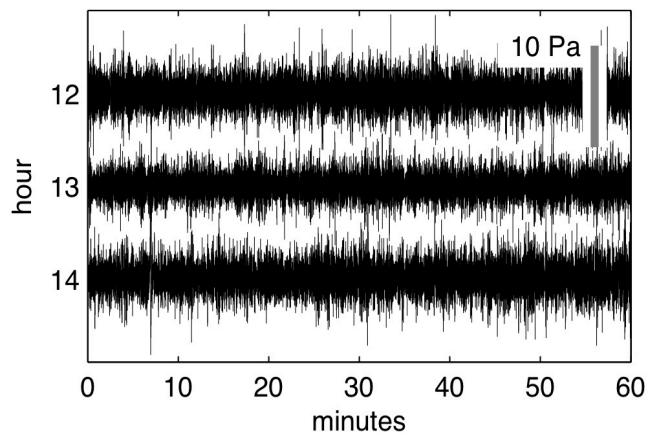

D) 3-hour averaged power spectral density

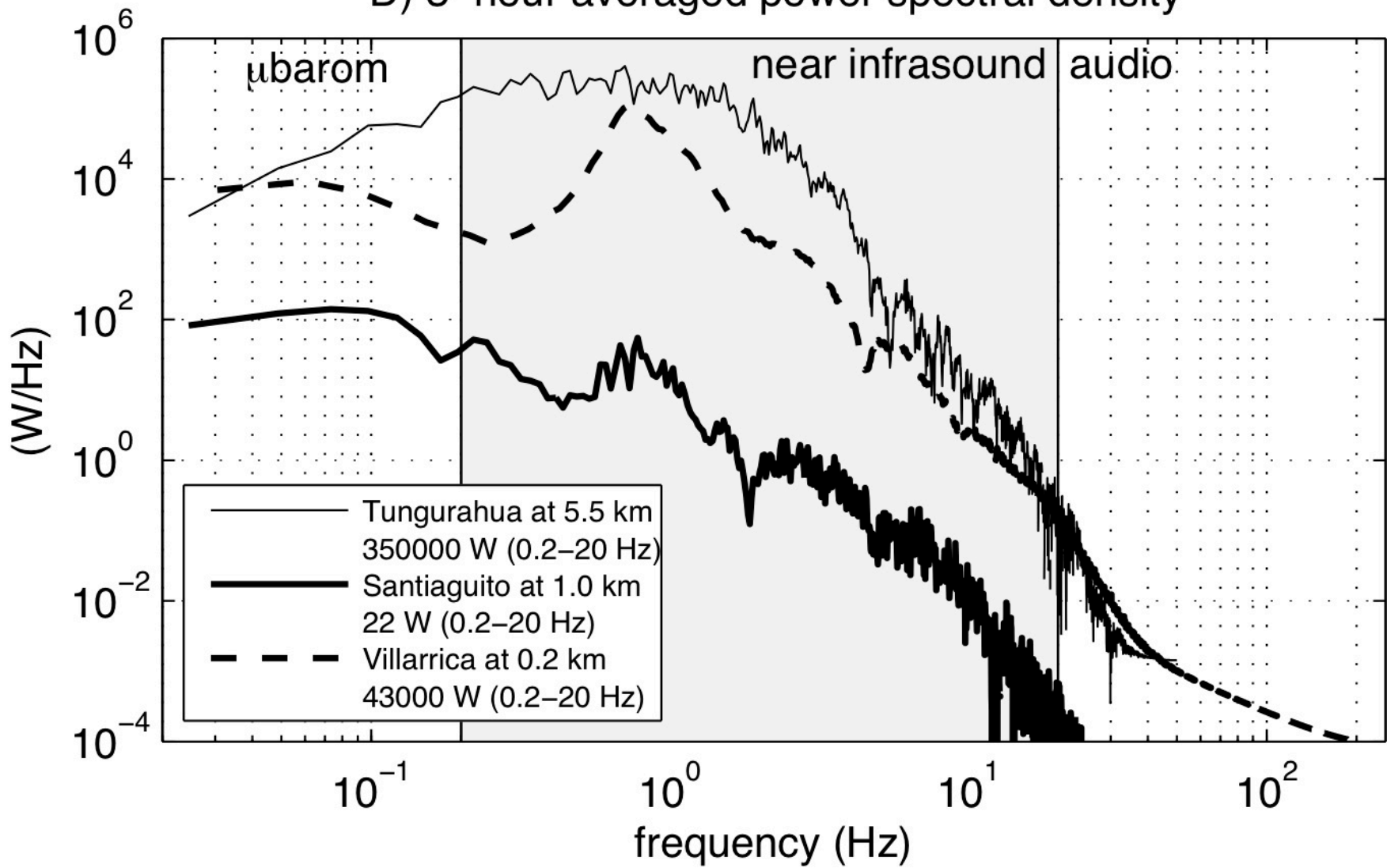

$$P(t) = \Omega \frac{\overline{p^2(t + r/c)}}{\rho c}$$

Seismo-acoustic datasets: Nick and John

Infrasound (low frequency acoustic waves) propagate out of the vent then through the atmosphere to the microphone.

Seismicity (body and surface waves) may originate from a diffuse zone (in conduit and elsewhere) and may be significantly filtered (scattered and attenuated) within the volcanic edifice.

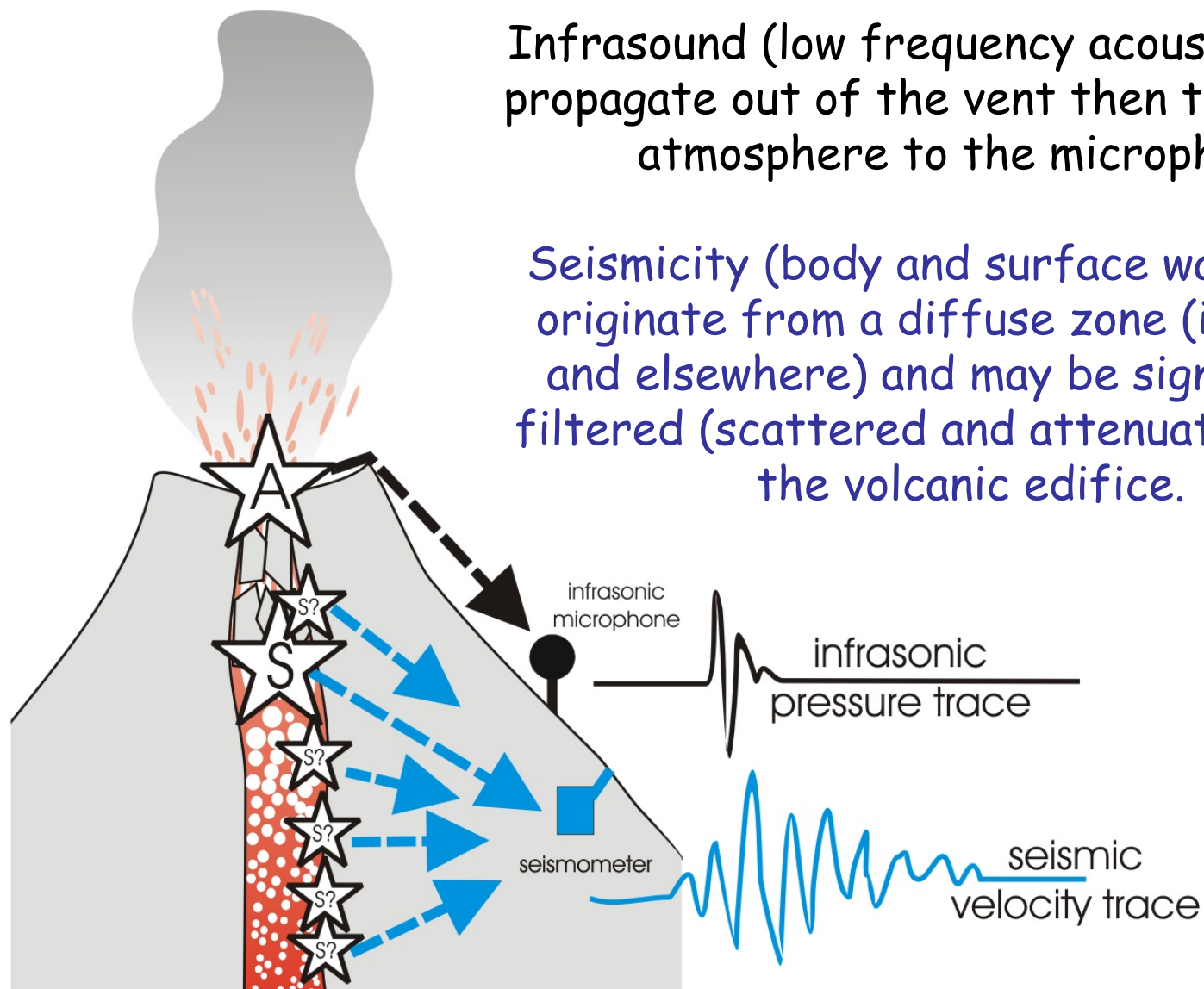

Acknowledgments:

- Mount Erebus - Rick Aster, Phil Kyle, Bill McIntosh, many others
- Tungurahua - Mario Ruiz, many others from IG-EPN, and GEOP572 class
- Santiaguito - John Lyons, Greg Waite, Rudiger Wolf (MTU), Richard Sanderson (NMT student), and many others.
- Villarrica - Akio Goto (Tohoku University), Richard Sanderson, Jake Anderson (students), Nick Varley (University of Colima)
- Kilauea video - Matt Patrick (Hawaii Volcanoes Observatory)

Funding

- NSF EAR
- National Geographic Expeditions Council

Types of Infrasonic Microphones



Electret condenser elements

Pro – nice signal-to-noise.

Pro – cheap..
One dollar a piece!

Con – frequency response rolls off in zone of interest



Machined silicon pressure transducer

Pro – response is linear down to DC.

Pro – relatively cheap - \$100 a piece

Con – doesn't filter out barometric pressure fluctuations

Con – Inferior signal-to-noise



Microbarometer (MB2000)

Pro – Flat response

Pro – very low noise

Con – a bit pricey (~ \$10,000)

Con – difficult to manage for field deployments